

Part number

RKAX IAP20



Angled Bulkhead mounting housing, CKA series, HNM - High Number of Matings series, with 1 lever, M20 cable entry, size "21.21"

Product description

Product type	Angled bulkhead mounting housing
Series	HNM - High Number of Matings
Closing type	With 1 lever
Size	Size "21.21"
Cable entry	With cable entry M20

Technical data

IP degree of protection IP44 - IP66 / IP67 / IP69 with CKR 65 (D)

Further technical details

Weight	67,50 g
Operating temperature range (min, max)	-40°C...+125°C

Material properties

Main material	Zinc die-cast
Other materials	Lever: stainless steel
Colour	RAL 7040 grey
RoHs conformity	Compliant
China RoHs - EFUP	E
REACH SVHC substances	No

General ordering information

EAN13 code	8015747140300
eCl@ss 8.1	27440202
ETIM 7.0	EC000437

Packaging Information

Packaging weight	7,41 kg
Packaging description	Carton box
Packaging quantity	100 Pcs
Packaging EAN code	8015747183192
Sub-packaging length	210,00 mm
Sub-packaging height	40,00 mm
Sub-packaging width	175,00 mm
Sub-packaging weight	0,74 kg
Sub-packaging volume	1,47 dm ³
Sub-packaging description	Carton box
Sub-packaging quantity	10 Pcs
Sub-packaging EAN barcode	8015747183208

Part number

RKAX IAP20



Catalogue drawings

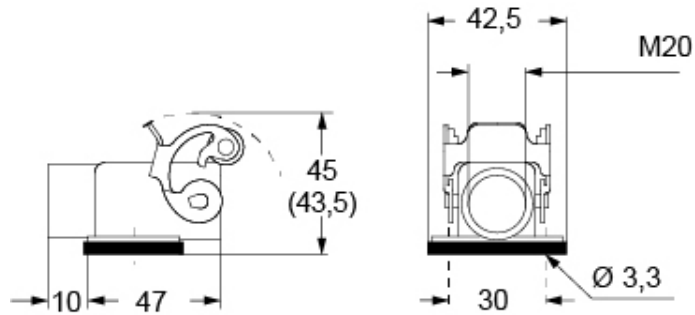

Catalogue drawings

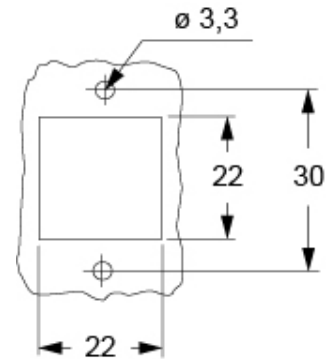

Notes

Dimensions shown in mm are not binding and may be changed without notice.