

Part number

RFV 06 L32



Hood, HNM - High Number of Matings series, with 2 pegs, M32 top cable entry without adapter, size "44.27", high construction

Product description

Product type	Hood
Series	HNM - High Number of Matings
Closing type	With 2 pegs
Size	Size 44.27
Cable entry	Top cable entry M32
Specification	High construction

Technical data

IP degree of protection IP65 / IP66 / IP69

Further technical details

Weight	1,00 g
Operating temperature range (min, max)	-40°C...+125°C

Material properties

Colour	RAL 7040 grey
RoHs conformity	Compliant
China RoHs - EFUP	E
REACH SVHC substances	No

Approvals / Standards

UL	ECBT2
cUL	ECBT8

General ordering information

EAN13 code	8015747255578
eCl@ss 8.1	27440202
ETIM 7.0	EC000437

Packaging Information

Packaging length	180,00 mm
Packaging height	105,00 mm
Packaging width	270,00 mm
Packaging volume	5,10 dm ³
Packaging description	Carton box
Packaging quantity	10 Pcs
Packaging EAN code	8015747083638
Sub-packaging description	Plastic packaging
Sub-packaging quantity	5 Pcs
Sub-packaging EAN barcode	8015747083799

Part number

RFV 06 L32



Catalogue drawings

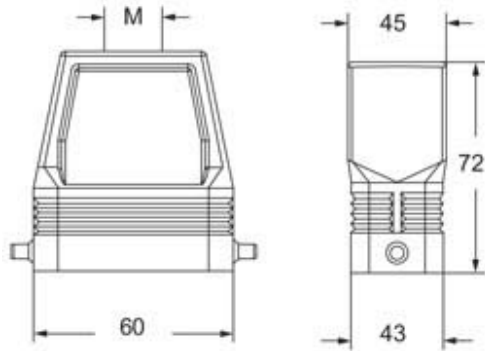

Notes

Dimensions shown in mm are not binding and may be changed without notice.
