

Part number

PK 1674 EB



Interlocked switched socket-outlet, PK series, 3 poles + PE, 7 h (black), 16 A, 480 ÷ 500 V, without fuse-carrier

Product description

Product type	Interlocked switched socket-outlet
Series	PK..EB
N. of poles	3 poles +
Clock position	7
Cable entry	Pg16
Specification	Without fuse-carrier

Technical data

Current	16 A
Voltage	480 ÷ 500 V
IP degree of protection	IP44

Further technical details

Weight	520,00 g
Operating temperature range (min, max)	-25°C ... +40°C
IK rating (impact degree of protection)	IK10

Material properties

Colour	RAL 7035 grey, RAL 9005 black
RoHs conformity	Compliant with exemption 6(c): copper alloy containing up to 4% lead by weight
China RoHs - EFUP	50
REACH SVHC substances	Yes Lead
SCIP number	Ce861c8d-b979-403b-96d9-80aef6dc281d

Approvals / Standards

Reference standard	EN 60309-1, -2 e -4
---------------------------	---------------------

General ordering information

EAN13 code	8015747080507
-------------------	---------------

Packaging Information

Sub-packaging weight	0,52 kg
Sub-packaging description	Carton box
Sub-packaging quantity	1 Pcs
Sub-packaging EAN barcode	8015747080514

Part number

PK 1674 EB



Catalogue drawings

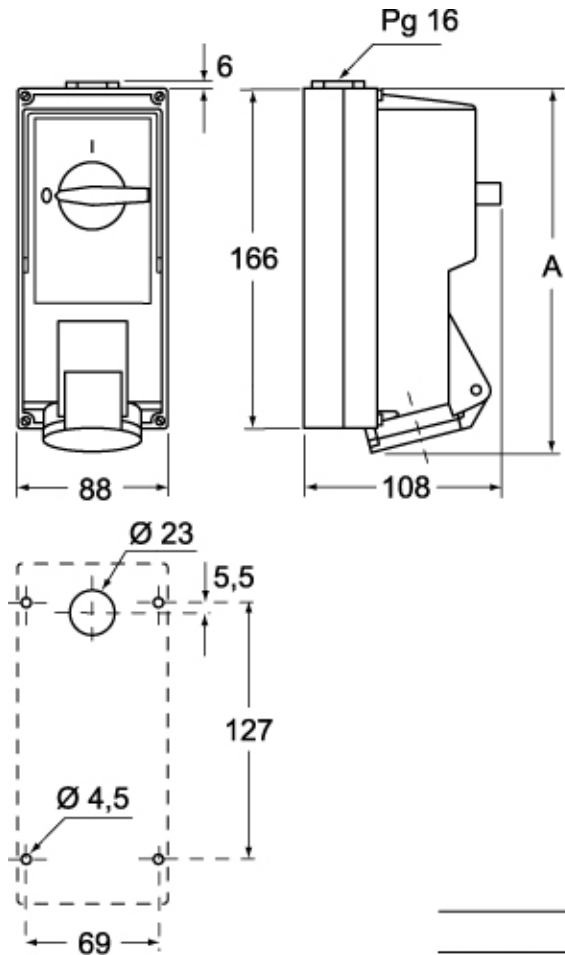

	A
2P+⊕	182
3P+⊕	182
3P+N+⊕	187

Notes

Dimensions shown in mm are not binding and may be changed without notice.