

Part number

PK 1644 EB



Interlocked switched socket-outlet, PK series,
3 poles + PE, 4 h (yellow), 16 A, 100 ÷ 130 V,
without fuse-carrier

Product description

Product type	Interlocked switched socket-outlet
Series	PK..EB
N. of poles	3 poles + 
Clock position	4
Size	114x228 fixing plates FC xx41 TB
Cable entry	Pg16
Specification	Without fuse-carrier

Technical data

Current	16 A
Voltage	100 ÷ 130 V
IP degree of protection	IP44

Further technical details

Weight	520,00 g
Operating temperature range (min, max)	-25°C ... +40°C
IK rating (impact degree of protection)	IK10

Material properties

Colour	RAL 7035 grey, RAL 1021 yellow
RoHs conformity	Compliant with exemption 6(c): copper alloy containing up to 4% lead by weight
China RoHs - EFUP	50
REACH SVHC substances	Yes Lead
SCIP number	Ce861c8d-b979-403b-96d9-80aef6dc281d

Approvals / Standards

Reference standard	EN 60309-1, -2 e -4
---------------------------	---------------------

General ordering information

EAN13 code	8015747080033
-------------------	---------------

Packaging Information

Sub-packaging weight	0,52 kg
Sub-packaging description	Carton box
Sub-packaging quantity	1 Pcs
Sub-packaging EAN barcode	8015747080040

Part number

PK 1644 EB



Catalogue drawings

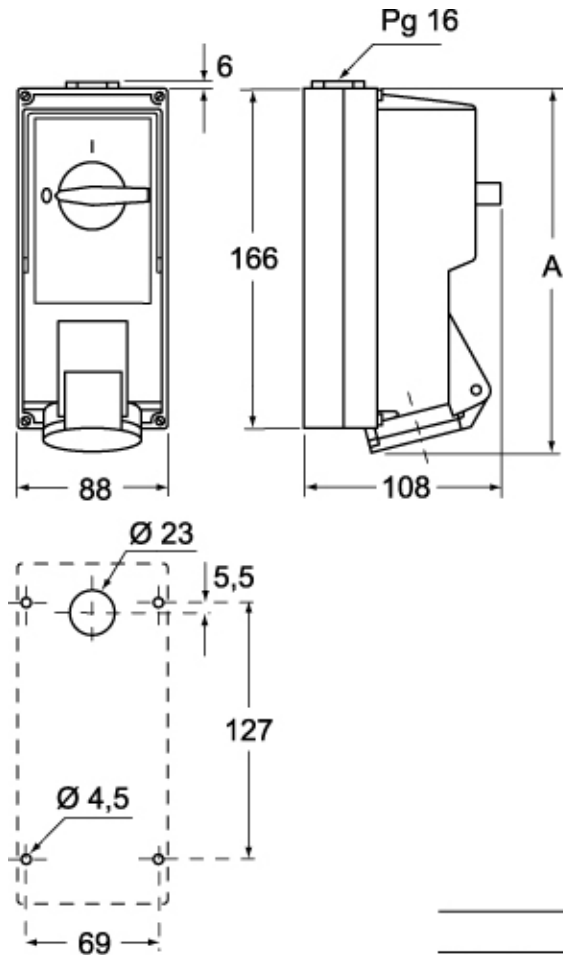

	A
2P+⊕	182
3P+⊕	182
3P+N+⊕	187

Notes

Dimensions shown in mm are not binding and may be changed without notice.