

Part number

PK 12593 PB5



Interlocked switched socket-outlet, PK series,
2 poles + PE, 9 h (red), 125 A, 380 ÷ 415 V,
NH00 fuse carrier

Product description		Material properties	
Product type	Interlocked switched socket-outlet	Colour	RAL 7035 grey, RAL 3000 red
Series	PK..PB5		Compliant with exemption 6(c): copper alloy containing up to 4% lead by weight
N. of poles	2 poles +	RoHs conformity	50
Clock position	9	China RoHs - EFUP	50
Specification	NH00 fuse carrier	REACH SVHC substances	Yes Lead
Technical data		SCIP number	Ce861c8d-b979-403b-96d9-80aef6dc281d
Current	125 A	Approvals / Standards	
Voltage	380 ÷ 415 V	Reference standard	EN 60309-1, -2 e -4
IP degree of protection	IP55	General ordering information	
Further technical details		EAN13 code	8015747158725
Weight	9.100,00 g	Packaging Information	
Operating temperature range (min, max)	-25°C ... +40°C	Packaging length	570,00 mm
IK rating (impact degree of protection)	IK10	Packaging height	200,00 mm
		Packaging width	265,00 mm
		Packaging weight	9,50 kg
		Packaging volume	30,21 dm ³
		Packaging description	Carton box
		Packaging quantity	1 Pcs
		Packaging EAN code	8015747003452
		Sub-packaging length	113,00 mm
		Sub-packaging height	36,00 mm
		Sub-packaging width	180,00 mm
		Sub-packaging volume	0,73 dm ³

Part number

PK 12593 PB5



Catalogue drawings

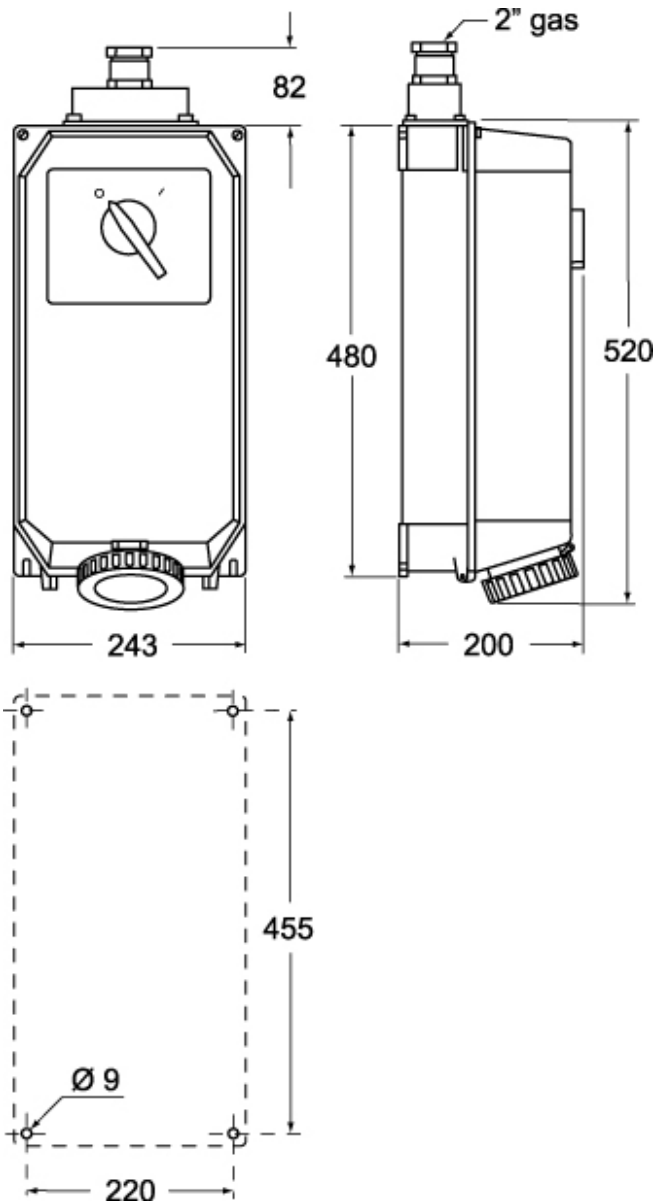

Notes

Dimensions shown in mm are not binding and may be changed without notice.