

Part number

PEW 6373 SI



Flush-mounting plug, PLUSO series, 2 poles + PE, 7 h (black), 63 A, 480 ÷ 500 V

Product description

Product type	Plug Flush-mounting
Series	PEW...SI, PLUSO
N. of poles	2 poles + 
Clock position	7

Technical data

Current	63 A
Voltage	480 ÷ 500 V
IP degree of protection	IP67

Further technical details

Operating temperature range (min, max)	-25°C ... +40°C
---	-----------------

Material properties

Colour	RAL 7035 grey, RAL 9005 black
---------------	-------------------------------

Approvals / Standards

Reference standard	EN 60309-1 and -2
---------------------------	-------------------

General ordering information

EAN13 code	8015747158428
-------------------	---------------

Part number

PEW 6373 SI



Catalogue drawings

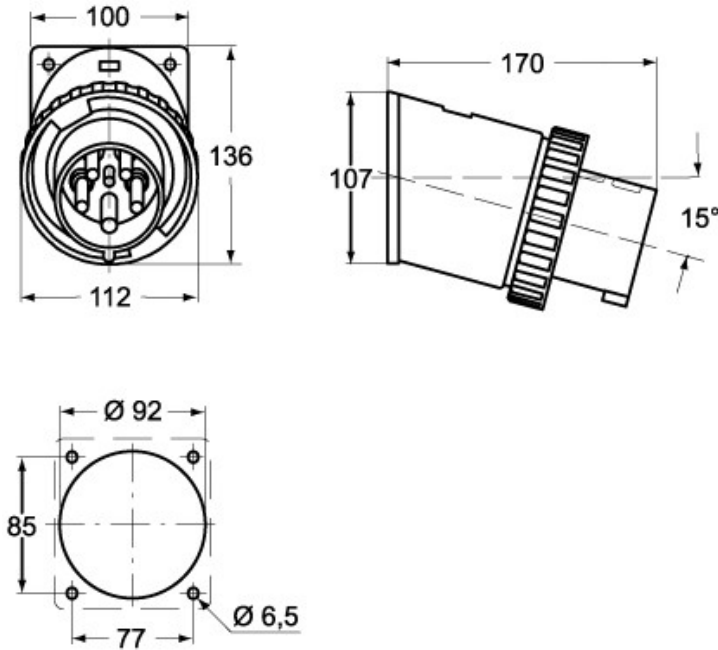

Notes

Dimensions shown in mm are not binding and may be changed without notice.

-
- Compliant with EN 60309-1 and -2
 - Enclosure, insert and locking ring in insulating, thermoplastic, self-extinguishing material
 - Flange with anti-ageing gasket
 - PE...SI types (IP44), RAL 7035 grey enclosure, plug mouth colour coded according to the operating voltage
 - PEW...SI (IP67) types, RAL 7035 grey enclosure, locking ring with gasket colour coded according to the operating voltage
 - Terminals with retained screws
 - 63A, 125A: with pilot contact
 - Nickel-plated contacts, available on request for 16A and 32A (standard on 63A and 125A). For the code of products with nickel-plated contacts (socket holes, plug pins), add "N" to the pre-code of the corresponding standard product code; for example: PE becomes PEN and PEW becomes PEWN.
 - IP44 and IP67 degrees of protection (EN 60529)
-