

Part number

PEW 6363 SI



Flush-mounting plug, PLUSO series, 2 poles + PE, 6 h (blue), 63 A, 200 ÷ 250 V

Product description

Product type	Plug Flush-mounting
Series	PEW...SI, PLUSO
N. of poles	2 poles +
Clock position	6

Technical data

Current	63 A
Voltage	200 ÷ 250 V
IP degree of protection	IP67

Further technical details

Weight	623,00 g
Operating temperature range (min, max)	-25°C ... +40°C

Material properties

Colour	RAL 7035 grey, RAL 5015 blue
RoHs conformity	Compliant with exemption 6(c): copper alloy containing up to 4% lead by weight
China RoHs - EFUP	50
REACH SVHC substances	Yes Lead
SCIP number	Ca7de37f-add8-4b77-9861-279c94903ade

Approvals / Standards

Reference standard	EN 60309-1 and -2
---------------------------	-------------------

General ordering information

EAN13 code	8015747077385
-------------------	---------------

Packaging Information

Packaging length	255,00 mm
Packaging height	195,00 mm
Packaging width	245,00 mm
Packaging weight	2,75 kg
Packaging volume	12,18 dm ³
Packaging description	Carton box
Packaging quantity	4 Pcs
Packaging EAN code	8015747077392

Part number

PEW 6363 SI



Catalogue drawings

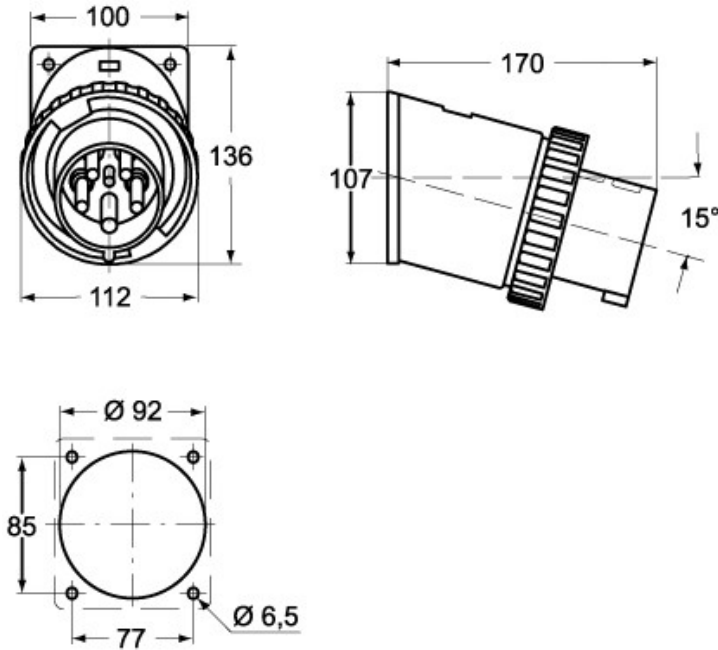

Notes

Dimensions shown in mm are not binding and may be changed without notice.

-
- Compliant with EN 60309-1 and -2
 - Enclosure, insert and locking ring in insulating, thermoplastic, self-extinguishing material
 - Flange with anti-ageing gasket
 - PE...SI types (IP44), RAL 7035 grey enclosure, plug mouth colour coded according to the operating voltage
 - PEW...SI (IP67) types, RAL 7035 grey enclosure, locking ring with gasket colour coded according to the operating voltage
 - Terminals with retained screws
 - 63A, 125A: with pilot contact
 - Nickel-plated contacts, available on request for 16A and 32A (standard on 63A and 125A). For the code of products with nickel-plated contacts (socket holes, plug pins), add "N" to the pre-code of the corresponding standard product code; for example: PE becomes PEN and PEW becomes PEWN.
 - IP44 and IP67 degrees of protection (EN 60529)
-