

Part number

PEW 63114 SM



Wall-mounting plug, PLUSO series, 3 poles + PE, 11 h (red), 63 A, 440 ÷ 460 V

Product description

Product type	Plug Wall-mounting
Series	PEW...SM, PLUSO
N. of poles	3 poles +
Clock position	11

Technical data

Current	63 A
Voltage	440 ÷ 460 V
IP degree of protection	IP67

Further technical details

Weight	1.250,00 g
Operating temperature range (min, max)	-25°C ... +40°C

Material properties

Colour	RAL 7035 grey, RAL 3000 red
RoHs conformity	Compliant with exemption 6(c): copper alloy containing up to 4% lead by weight
China RoHs - EFUP	50
REACH SVHC substances	Yes Lead
SCIP number	Ca7de37f-add8-4b77-9861-279c94903ade

Approvals / Standards

Reference standard	EN 60309-1 and -2
---------------------------	-------------------

General ordering information

EAN13 code	8015747158169
-------------------	---------------

Packaging Information

Packaging length	210,00 mm
Packaging height	135,00 mm
Packaging width	280,00 mm
Packaging weight	1,46 kg
Packaging volume	7,94 dm ³
Packaging description	Carton box
Packaging quantity	1 Pcs
Packaging EAN code	8015747259750

Part number

PEW 63114 SM



Catalogue drawings

(63A) PEW ... SM

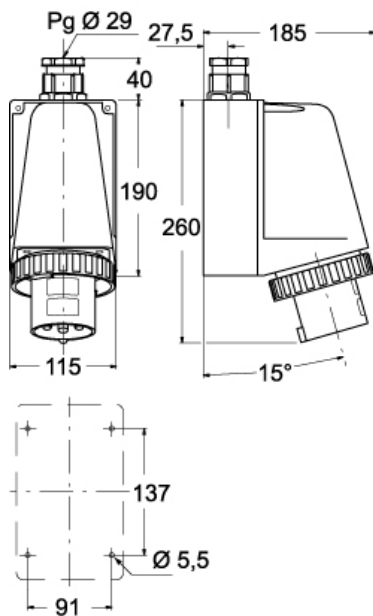

(125A) PEW ... SM

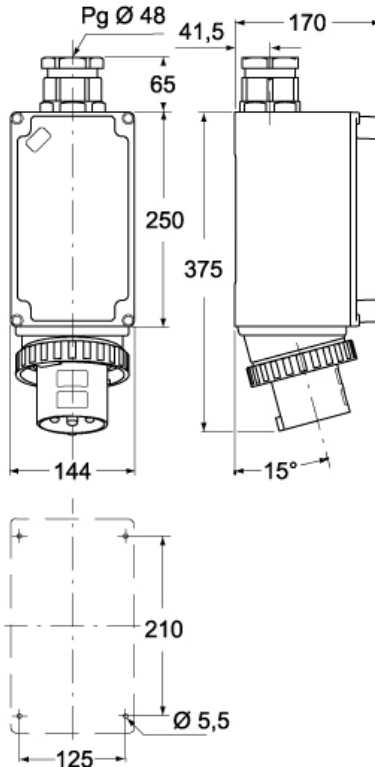

Notes

Dimensions shown in mm are not binding and may be changed without notice.

- Compliant with EN 60309-1 and -2
- Enclosure, insert and locking ring in insulating, thermoplastic, self-extinguishing material
- PE...SM types (IP44), enclosure colour coded according to the operating voltage, top entry with threaded grommet (replaceable with cable gland)
- PEW...SM types (IP67), RAL 7035 grey enclosure, locking ring with gasket colour coded according to the operating voltage, top entry with cable gland
- Terminals with retained screws
- 63A, 125A: with pilot contact
- Nickel-plated contacts, available on request for 16A and 32A (standard on 63A and 125A). For the code of products with nickel-plated contacts (socket holes, plug pins), add "N" to the pre-code of the corresponding standard product code; for example: PE becomes PEN and PEW becomes PEWN.
- 125A: with terminal block for the anchoring of incoming cables, already connected to socket
- IP44 and IP67 degrees of protection (EN 6052)