

Part number

# PEW 3275 PP



Wall-mounting socket outlet, PLUSO series, 3 poles + N + PE, 7 h (black), 32 A, 277/480 ÷ 288/500 V

#### Product description

<b>Product type</b>	Socket Wall-mounting
<b>Series</b>	PEW...PP, PLUSO
<b>N. of poles</b>	3 poles + N + 
<b>Clock position</b>	7

#### Technical data

<b>Current</b>	32 A
<b>Voltage</b>	277/480 ÷ 288/500 V
<b>IP degree of protection</b>	IP67

#### Further technical details

<b>Weight</b>	550,00 g
<b>Operating temperature range (min, max)</b>	-25°C ... +40°C

#### Material properties

<b>Colour</b>	RAL 7035 grey, RAL 9005 black
<b>RoHs conformity</b>	Compliant with exemption 6(c): copper alloy containing up to 4% lead by weight
<b>China RoHs - EFUP</b>	50
<b>REACH SVHC substances</b>	Yes Lead
<b>SCIP number</b>	Ca7de37f-add8-4b77-9861-279c94903ade

#### Approvals / Standards

<b>Reference standard</b>	EN 60309-1 and -2
---------------------------	-------------------

#### General ordering information

<b>EAN13 code</b>	8015747075893
-------------------	---------------

#### Packaging Information

<b>Packaging length</b>	440,00 mm
<b>Packaging height</b>	180,00 mm
<b>Packaging width</b>	330,00 mm
<b>Packaging weight</b>	5,75 kg
<b>Packaging volume</b>	26,14 dm <sup>3</sup>
<b>Packaging description</b>	Carton box
<b>Packaging quantity</b>	10 Pcs
<b>Packaging EAN code</b>	8015747075909

Part number

# PEW 3275 PP



Catalogue drawings

( 16 / 32A) PEW ... PP

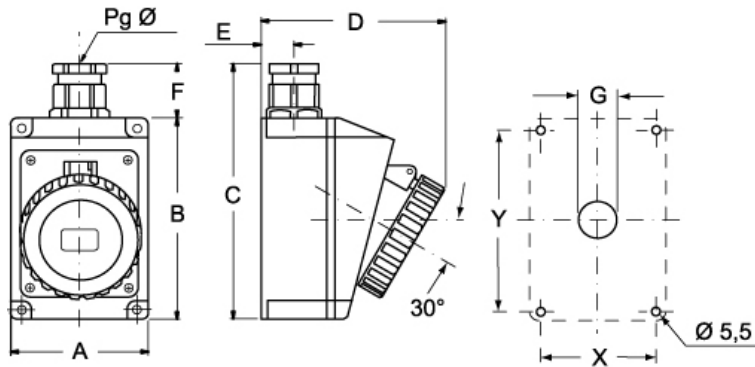

PEW ... PP	A	B	C	D	E	F	G	X	Y	Pg Ø
<b>16A</b> 2P+⊕	75	115	150	105	19	33	Ø22	65	105	16
3P+⊕	75	115	150	108	19	33	Ø22	65	105	16
3P+N+⊕	100	130	172	120	22	33	Ø22	85	115	21
<b>32A</b> 2P+⊕	100	130	172	120	22	42	Ø28	85	115	21
3P+⊕	100	130	172	120	22	42	Ø28	85	115	21
3P+N+⊕	100	130	172	120	22	42	Ø28	85	115	21

## Notes

Dimensions shown in mm are not binding and may be changed without notice.

- Compliant with EN 60309-1 and -2
- Enclosure, insert and spring lid in insulating, thermoplastic, self-extinguishing material
- RAL 7035 grey enclosure, spring lid colour coded according to the operating voltage
- PE...PP types (IP44), spring lid, entry with threaded grommet (replaceable with a cable gland)
- PEW...PP types (IP67), spring lid with locking ring and gasket, entry with cable gland
- Terminals with retained screws
- 63A, 125A: with pilot contact
- Nickel-plated contacts, available on request for 16A and 32A (standard on 63A and 125A). For the code of products with nickel-plated contacts (socket holes, plug pins), add "N" to the pre-code of the corresponding standard product code; for example: PE becomes PEN and PEW becomes PEWN.
- 125A: with terminal block for the anchoring of incoming cables, already connected to socket
- IP44 and IP67 degrees of protection (EN 60529)