

Part number

PEW 32104 SI



Flush-mounting plug, PLUSO series, 3 poles + PE, 10 h (green), 32 A, > 50 V

Product description

Product type	Plug Flush-mounting
Series	PEW...SI, PLUSO
N. of poles	3 poles + 
Clock position	10

Technical data

Current	32 A
Voltage	> 50 V
IP degree of protection	IP67

Further technical details

Operating temperature range (min, max)	-25°C ... +40°C
---	-----------------

Material properties

Colour	RAL 7035 grey, RAL 6017 green
---------------	-------------------------------

Approvals / Standards

Reference standard	EN 60309-1 and -2
---------------------------	-------------------

General ordering information

EAN13 code	8015747157377
-------------------	---------------

Part number

PEW 32104 SI



Catalogue drawings

(16 / 32A) PEW ... SI

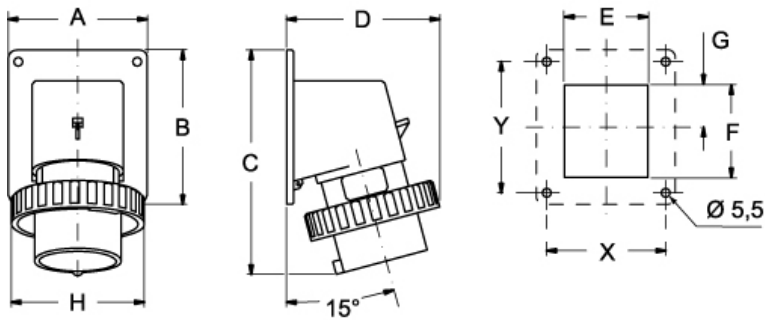

PEW ... SI	A	B	C	D	E	F	G	H	X	Y
16A 2P+⊕	65	82	126	81	41	43	21,5	70	52	60
3P+⊕	65	82	126	81	47	43	24,5	78	52	60
3P+N+⊕	90	100	146	93	54	60	27,5	86	77	85
32A 2P+⊕	90	100	160	101	55	60	27,5	92	77	85
3P+⊕	90	100	160	101	55	60	27,5	92	77	85
3P+N+⊕	90	100	160	101	62	60	27,5	100	77	85

Notes

Dimensions shown in mm are not binding and may be changed without notice.

- Compliant with EN 60309-1 and -2
- Enclosure, insert and locking ring in insulating, thermoplastic, self-extinguishing material
- Flange with anti-ageing gasket
- PE...SI types (IP44), RAL 7035 grey enclosure, plug mouth colour coded according to the operating voltage
- PEW...SI (IP67) types, RAL 7035 grey enclosure, locking ring with gasket colour coded according to the operating voltage
- Terminals with retained screws
- 63A, 125A: with pilot contact
- Nickel-plated contacts, available on request for 16A and 32A (standard on 63A and 125A). For the code of products with nickel-plated contacts (socket holes, plug pins), add "N" to the pre-code of the corresponding standard product code; for example: PE becomes PEN and PEW becomes PEWN.
- IP44 and IP67 degrees of protection (EN 60529)