

Part number

PE 3273 SI



Flush-mounting plug, PLUSO series, 2 poles + PE, 7 h (black), 32 A, 480 ÷ 500 V

Product description

Product type	Plug Flush-mounting
Series	PE...SI, PLUSO
N. of poles	2 poles + 
Clock position	7

Technical data

Current	32 A
Voltage	480 ÷ 500 V
IP degree of protection	IP44

Further technical details

Operating temperature range (min, max)	-25°C ... +40°C
---	-----------------

Material properties

Colour	RAL 7035 grey, RAL 9005 black
---------------	-------------------------------

Approvals / Standards

Reference standard	EN 60309-1 and -2
---------------------------	-------------------

General ordering information

EAN13 code	8015747155748
-------------------	---------------

Part number

PE 3273 SI



Catalogue drawings

(16 / 32A) PE ... SI

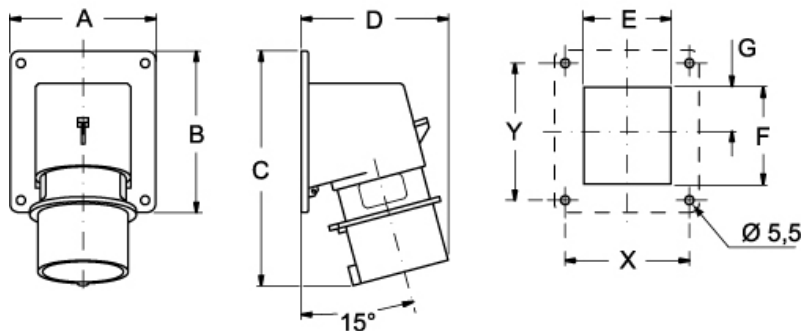

PE ... SI	A	B	C	D	E	F	G	X	Y
16A 2P+⊕	65	82	126	81	41	43	21,5	52	60
	65	82	126	81	47	43	21,5	52	60
	90	100	146	93	54	60	27,5	77	85
32A 2P+⊕	90	100	160	101	55	60	27,5	77	85
	90	100	160	101	55	60	27,5	77	85
	90	100	160	106	62	60	27,5	77	85

Notes

Dimensions shown in mm are not binding and may be changed without notice.

- Compliant with EN 60309-1 and -2
- Enclosure, insert and locking ring in insulating, thermoplastic, self-extinguishing material
- Flange with anti-ageing gasket
- PE...SI types (IP44), RAL 7035 grey enclosure, plug mouth colour coded according to the operating voltage
- PEW...SI (IP67) types, RAL 7035 grey enclosure, locking ring with gasket colour coded according to the operating voltage
- Terminals with retained screws
- 63A, 125A: with pilot contact
- Nickel-plated contacts, available on request for 16A and 32A (standard on 63A and 125A). For the code of products with nickel-plated contacts (socket holes, plug pins), add "N" to the pre-code of the corresponding standard product code; for example: PE becomes PEN and PEW becomes PEWN.
- IP44 and IP67 degrees of protection (EN 60529)