

Part number

# PE 3245 SI



Flush-mounting plug, PLUSO series, 3 poles + N + PE, 4 h (yellow), 32 A, 57/100 ÷ 75/130 V

#### Product description

<b>Product type</b>	Plug Flush-mounting
<b>Series</b>	PE...SI, PLUSO
<b>N. of poles</b>	3 poles + N + 
<b>Clock position</b>	4
<b>Size</b>	Socket fixing centre distance 77 x 85 mm

#### Technical data

<b>Current</b>	32 A
<b>Voltage</b>	57/100 ÷ 75/130 V
<b>IP degree of protection</b>	IP44

#### Further technical details

<b>Weight</b>	254,00 g
<b>Operating temperature range (min, max)</b>	-25°C ... +40°C

#### Material properties

<b>Colour</b>	RAL 7035 grey, RAL 1021 yellow
<b>RoHs conformity</b>	Compliant with exemption 6(c): copper alloy containing up to 4% lead by weight
<b>China RoHs - EFUP</b>	50
<b>REACH SVHC substances</b>	Yes Lead
<b>SCIP number</b>	Ca7de37f-add8-4b77-9861-279c94903ade

#### Approvals / Standards

<b>Reference standard</b>	EN 60309-1 and -2
---------------------------	-------------------

#### General ordering information

<b>EAN13 code</b>	8015747067034
-------------------	---------------

#### Packaging Information

<b>Packaging length</b>	355,00 mm
<b>Packaging height</b>	195,00 mm
<b>Packaging width</b>	325,00 mm
<b>Packaging weight</b>	3,20 kg
<b>Packaging volume</b>	22,50 dm <sup>3</sup>
<b>Packaging description</b>	Carton box
<b>Packaging quantity</b>	10 Pcs
<b>Packaging EAN code</b>	8015747110181

Part number

# PE 3245 SI



Catalogue drawings

(16 / 32A) PE ... SI

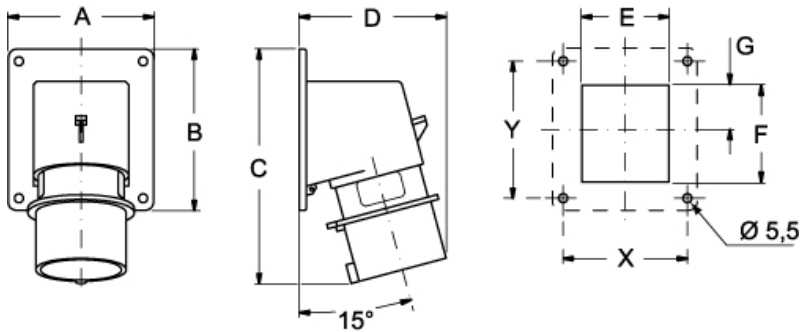

PE ... SI	A	B	C	D	E	F	G	X	Y
<b>16A</b> 2P+⊕	65	82	126	81	41	43	21,5	52	60
	65	82	126	81	47	43	21,5	52	60
	90	100	146	93	54	60	27,5	77	85
<b>32A</b> 2P+⊕	90	100	160	101	55	60	27,5	77	85
	90	100	160	101	55	60	27,5	77	85
	90	100	160	106	62	60	27,5	77	85

## Notes

Dimensions shown in mm are not binding and may be changed without notice.

- Compliant with EN 60309-1 and -2
- Enclosure, insert and locking ring in insulating, thermoplastic, self-extinguishing material
- Flange with anti-ageing gasket
- PE...SI types (IP44), RAL 7035 grey enclosure, plug mouth colour coded according to the operating voltage
- PEW...SI (IP67) types, RAL 7035 grey enclosure, locking ring with gasket colour coded according to the operating voltage
- Terminals with retained screws
- 63A, 125A: with pilot contact
- Nickel-plated contacts, available on request for 16A and 32A (standard on 63A and 125A). For the code of products with nickel-plated contacts (socket holes, plug pins), add "N" to the pre-code of the corresponding standard product code; for example: PE becomes PEN and PEW becomes PEWN.
- IP44 and IP67 degrees of protection (EN 60529)