

Part number

# PE 3234 SA



Mobile plug, PLUSO series, 3 poles + PE, 3 h (red), 32 A, 380 ÷ 380 V, angled

#### Product description

<b>Product type</b>	Plug Mobile
<b>Series</b>	PE...SA, PLUSO
<b>N. of poles</b>	3 poles + 
<b>Clock position</b>	3
<b>Specification</b>	Angled

#### Technical data

<b>Current</b>	32 A
<b>Voltage</b>	380V (50Hz.) 440V (60Hz.)
<b>IP degree of protection</b>	IP44

#### Further technical details

<b>Operating temperature range (min, max)</b>	-25°C ... +40°C
---	-----------------

#### Material properties

<b>Colour</b>	RAL 7035 grey, RAL 3000 red
---------------	-----------------------------

#### Approvals / Standards

<b>Reference standard</b>	EN 60309-1 and -2
---------------------------	-------------------

#### General ordering information

<b>EAN13 code</b>	8015747155502
-------------------	---------------

Part number

# PE 3234 SA



## Catalogue drawings

(16 / 32A) PE ... SA

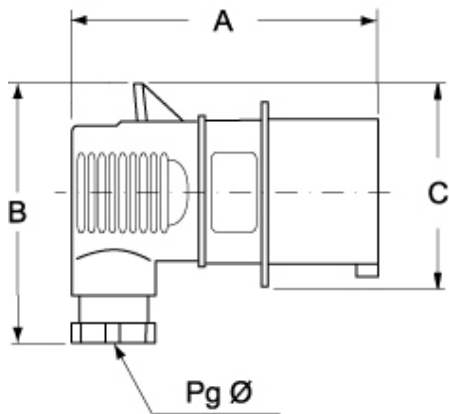

PE...SA	A	B	C	Pg Ø
<b>16A</b> 2P+⊕	100	77	59	13,5
3P+⊕	100	84	68	16
3P+N+⊕	106	91	77	16
<b>32A</b> 2P+⊕	131	100	82	21
3P+⊕	131	100	82	21
3P+N+⊕	131	107	93	21

## Notes

Dimensions shown in mm are not binding and may be changed without notice.

plug pins), add "N" to the pre-code of the corresponding standard product code; for example: PE becomes PEN and PEW becomes PEWN.

- IP44 and IP67 degrees of protection (EN 60529)

- Compliant with EN 60309-1 and -2
- Enclosure, insert and locking ring in insulating, thermoplastic, self-extinguishing material
- Cable anchoring collar incorporated in the insert
- Entry with cable gland
- PE...SA types (IP44), enclosure colour coded according to the operating voltage
- PEW...SA types (IP67), RAL 7035 grey enclosure, locking ring with gasket colour coded according to the operating voltage
- Terminals with retained screws
- Nickel-plated contacts, available on request for 16A and 32A. For the code of products with nickel-plated contacts (socket holes,