

Part number

PE 3224 SA



Mobile plug, PLUSO series, 3 poles + PE, 2 h (green), 32 A, > 50 V, angled

Product description

Product type	Plug Mobile
Series	PE...SA, PLUSO
N. of poles	3 poles + 
Clock position	2
Specification	Angled

Technical data

Current	32 A
Voltage	> 50 V
IP degree of protection	IP44

Further technical details

Operating temperature range (min, max)	-25°C ... +40°C
---	-----------------

Material properties

Colour	RAL 7035 grey, RAL 6017 green
---------------	-------------------------------

Approvals / Standards

Reference standard	EN 60309-1 and -2
---------------------------	-------------------

General ordering information

EAN13 code	8015747155410
-------------------	---------------

Part number

PE 3224 SA



Catalogue drawings

(16 / 32A) PE ... SA

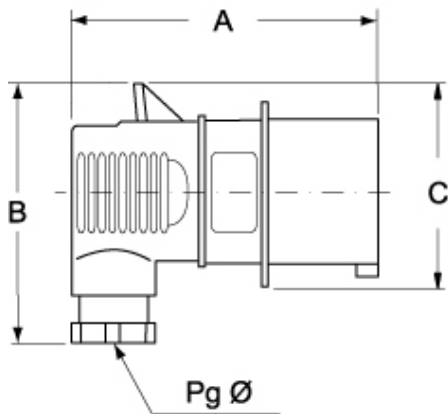

PE...SA	A	B	C	Pg Ø
16A 2P+⊕	100	77	59	13,5
3P+⊕	100	84	68	16
3P+N+⊕	106	91	77	16
32A 2P+⊕	131	100	82	21
3P+⊕	131	100	82	21
3P+N+⊕	131	107	93	21

Notes

Dimensions shown in mm are not binding and may be changed without notice.

plug pins), add "N" to the pre-code of the corresponding standard product code; for example: PE becomes PEN and PEW becomes PEWN.

- IP44 and IP67 degrees of protection (EN 60529)

- Compliant with EN 60309-1 and -2
- Enclosure, insert and locking ring in insulating, thermoplastic, self-extinguishing material
- Cable anchoring collar incorporated in the insert
- Entry with cable gland
- PE...SA types (IP44), enclosure colour coded according to the operating voltage
- PEW...SA types (IP67), RAL 7035 grey enclosure, locking ring with gasket colour coded according to the operating voltage
- Terminals with retained screws
- Nickel-plated contacts, available on request for 16A and 32A. For the code of products with nickel-plated contacts (socket holes,