

Part number

PE 1693 PP



Wall-mounting socket outlet, PLUSO series, 2 poles + PE, 9 h (red), 16 A, 380 ÷ 415 V

Product description		Material properties	
Product type	Socket Wall-mounting	Colour	RAL 7035 grey, RAL 3000 red
Series	PE...PP, PLUSO	RoHs conformity	Compliant with exemption 6(c): copper alloy containing up to 4% lead by weight
N. of poles	2 poles +	China RoHs - EFUP	50
Clock position	9	REACH SVHC substances	Yes Lead
Technical data		SCIP number	Ca7de37f-add8-4b77-9861-279c94903ade
Current	16 A	Approvals / Standards	
Voltage	380 ÷ 415 V	Reference standard	EN 60309-1 and -2
IP degree of protection	IP44	General ordering information	
Further technical details		EAN13 code	8015747065344
Weight	189,00 g	Packaging Information	
Operating temperature range (min, max)	-25°C ... +40°C	Packaging length	208,00 mm
		Packaging height	140,00 mm
		Packaging width	290,00 mm
		Packaging weight	2,04 kg
		Packaging volume	8,44 dm ³
		Packaging description	Carton box
		Packaging quantity	10 Pcs
		Packaging EAN code	8015747065351

Part number

PE 1693 PP



Catalogue drawings

(16 / 32A) PE ... PP

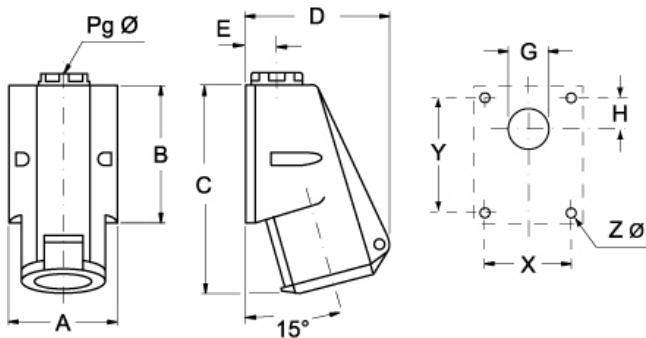

PE ... PP	A	B	C	D	E	G	H	X	Y	Pg Ø	Z Ø
16A 2P+⊕	70	82	126	92	20	Ø22	16	53	65	16	4,5
3P+⊕	70	82	126	92	20	Ø22	16	53	65	16	4,5
3P+N+⊕	70	82	132	106	20	Ø22	16	53	65	16	4,5
32A 2P+⊕	86	104	159	110	24	Ø28	17	61	79	21	6,5
3P+⊕	86	104	159	110	24	Ø28	17	61	79	21	6,5
3P+N+⊕	86	104	159	110	24	Ø28	17	61	79	21	6,5

Notes

Dimensions shown in mm are not binding and may be changed without notice.

- Compliant with EN 60309-1 and -2
- Enclosure, insert and spring lid in insulating, thermoplastic, self-extinguishing material
- RAL 7035 grey enclosure, spring lid colour coded according to the operating voltage
- PE...PP types (IP44), spring lid, entry with threaded grommet (replaceable with a cable gland)
- PEW...PP types (IP67), spring lid with locking ring and gasket, entry with cable gland
- Terminals with retained screws
- 63A, 125A: with pilot contact
- Nickel-plated contacts, available on request for 16A and 32A (standard on 63A and 125A). For the code of products with nickel-plated contacts (socket holes, plug pins), add "N" to the pre-code of the corresponding standard product code; for example: PE becomes PEN and PEW becomes PEWN.
- 125A: with terminal block for the anchoring of incoming cables, already connected to socket
- IP44 and IP67 degrees of protection (EN 60529)