

Part number

MZO 25 L20



Hood, IL-BRID series, with 2 pegs, M20 side cable entry, size "66.16"

Product description

Product type	Hood
Series	IL-BRID
Closing type	With 2 pegs
Size	Size 66.16
Cable entry	Side cable entry M20

Technical data

IP degree of protection	IP66 / IP67 / IP69
--------------------------------	--------------------

Further technical details

Weight	116,00 g
Operating temperature range (min, max)	-40°C...+125°C

Material properties

Other materials	Gasket: NBR
Colour	RAL 7040 grey
RoHs conformity	Compliant
China RoHs - EFUP	E
REACH SVHC substances	No

Approvals / Standards

UL	ECBT2
cUL	ECBT8

General ordering information

EAN13 code	8015747060301
eCl@ss 8.1	27440202
ETIM 7.0	EC000437

Packaging Information

Packaging length	210,00 mm
Packaging height	75,00 mm
Packaging width	180,00 mm
Packaging weight	2,45 kg
Packaging volume	2,84 dm ³
Packaging description	Carton box
Packaging quantity	20 Pcs
Packaging EAN code	8015747208499
Sub-packaging weight	0,61 kg
Sub-packaging description	Plastic packaging
Sub-packaging quantity	5 Pcs
Sub-packaging EAN barcode	8015747208505

Part number

MZO 25 L20



Catalogue drawings

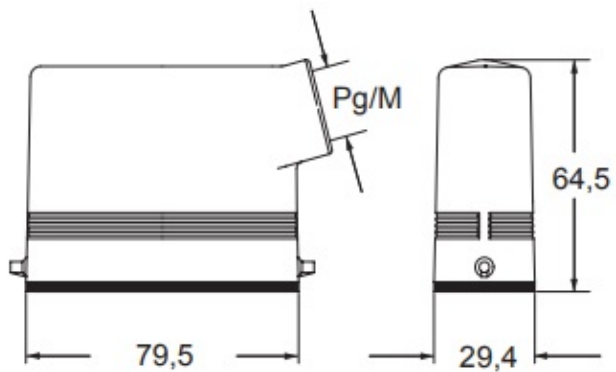

Notes

Dimensions shown in mm are not binding and may be changed without notice.