

Part number

MMAP 03 CP40



Surface mounting housing, 830V series, with 4 pegs, M40 cable entry, size "57.27", high construction, with plastic cover

Product description

Product type	Surface mounting housing
Series	830V
Closing type	With 4 pegs
Size	Size 57.27
Cable entry	With cable entry M40
Specification	High construction, with plastic cover

Technical data

IP degree of protection IP65

Further technical details

Operating temperature range (min, max) -40°C...+125°C

Material properties

Colour	RAL 7040 grey
RoHs conformity	Compliant
China RoHs - EFUP	E
REACH SVHC substances	No

Approvals / Standards

Certifications	DNV, BV
UL	ECBT2
cUL	ECBT8

General ordering information

EAN13 code 8015747057226

Packaging Information

Sub-packaging description	Plastic packaging
Sub-packaging quantity	5 Pcs
Sub-packaging EAN barcode	8015747106191

Part number

MMAP 03 CP40



Catalogue drawings

CMP CMAP - MMP MMAP

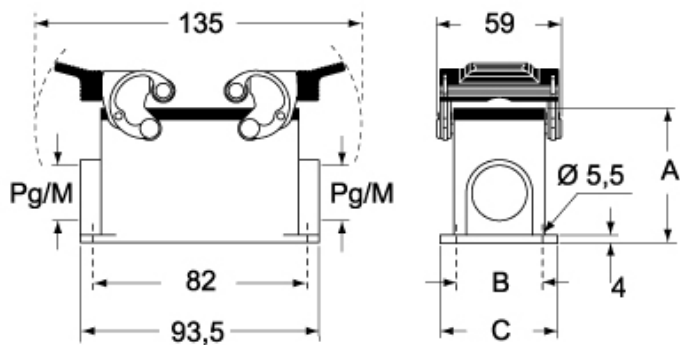

CMP CS/CP CMAP CS/CP - MMP CS/CP MMAP CS/CP

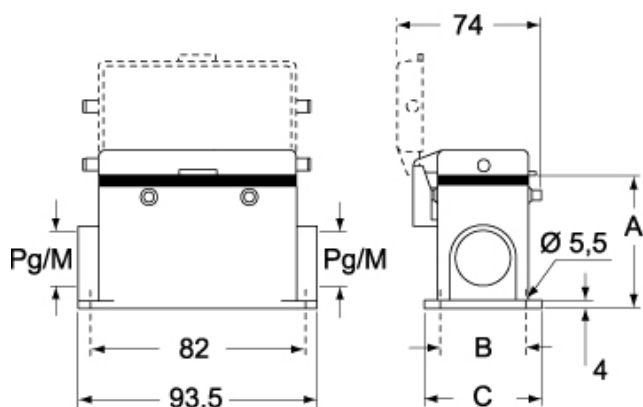

	A	B	C
CMP / MMP	57	40	52
CMAP / MMAP	73	45	57
CMP CS / MMP CS	57	40	52
CMAP CS / MMAP CS	73	45	57
CMP CP / MMP CP	57	40	52
CMAP CP / MMAP CP	73	45	57

Notes

Dimensions shown in mm are not binding and may be changed without notice.