

Part number

MKA IAF25



Angled Bulkhead mounting housing, CKA series, with 1 lever, M25 fixing thread, size "21.21"

Product description

Product type	Angled bulkhead mounting housing
Series	CKA
Closing type	With 1 lever
Size	Size "21.21"
Cable entry	Round threaded appendix M25

Technical data

IP degree of protection IP44 - IP66 / IP67 / IP69 with CKR 65 (D)

Further technical details

Weight	38,00 g
Operating temperature range (min, max)	-40°C...+125°C

Material properties

Main material	Zinc die-cast
Other materials	Lever: Galvanized steel Gasket: TPE
Colour	RAL 7040 grey
RoHs conformity	Compliant
China RoHs - EFUP	E
REACH SVHC substances	No

Approvals / Standards

UL	ECBT2
cUL	ECBT8

General ordering information

EAN13 code	8015747176019
eCl@ss 8.1	27440202
ETIM 7.0	EC000437

Packaging Information

Sub-packaging length	185,00 mm
Sub-packaging height	40,00 mm
Sub-packaging width	155,00 mm
Sub-packaging weight	0,38 kg
Sub-packaging volume	1,15 dm ³
Sub-packaging description	Carton box
Sub-packaging quantity	10 Pcs
Sub-packaging EAN barcode	8015747176026

Part number

MKA IAF25



Catalogue drawings

MKA IAF

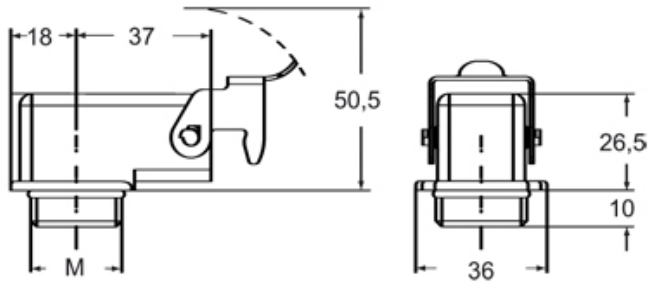

Catalogue drawings

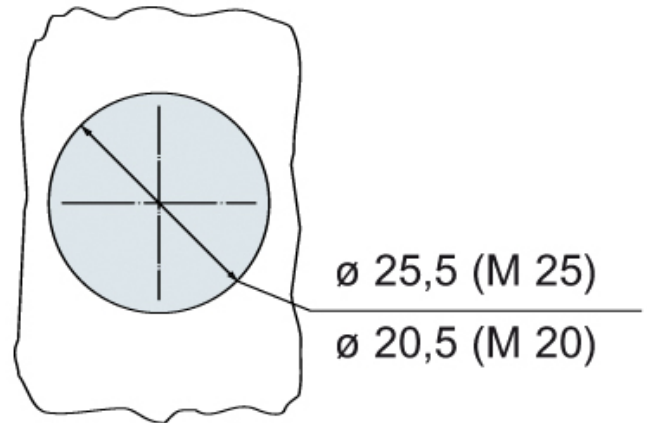

Notes

(*) counternut supplied on request, see catalogue cable glands (part No. AS M20N and AS M25N metal version, AS M20L and AS M25L insulating version)

Dimensions shown in mm are not binding and may be changed without notice.