

Part number

MHV 06 LX25



Hood, C-TYPE series, with 1 lever, M25 top cable entry, size "44.27"

Product description

Product type	Hood
Series	C-TYPE
Closing type	With 1 lever
Size	Size 44.27
Cable entry	Top cable entry M25

Technical data

IP degree of protection IP65 / IP66 / IP69

Further technical details

Weight	134,00 g
Operating temperature range (min, max)	-40°C...+125°C

Material properties

Other materials	Lever: Stainless steel, polyamide (PA)
Colour	RAL 7040 grey
RoHs conformity	Compliant
China RoHs - EFUP	E
REACH SVHC substances	No

Approvals / Standards

Certifications	DNV, BV
UL	ECBT2
cUL	ECBT8

General ordering information

EAN13 code	8015747055468
eCl@ss 8.1	27440202
ETIM 7.0	EC000437

Packaging Information

Packaging length	180,00 mm
Packaging height	105,00 mm
Packaging width	270,00 mm
Packaging weight	1,34 kg
Packaging volume	5,10 dm ³
Packaging description	Carton box
Packaging quantity	10 Pcs
Packaging EAN code	8015747256551
Sub-packaging weight	0,67 kg
Sub-packaging description	Plastic packaging
Sub-packaging quantity	5 Pcs
Sub-packaging EAN barcode	8015747055475

Part number

MHV 06 LX25



Catalogue drawings

CHO LX CHV LX - MHO LX MHV LX

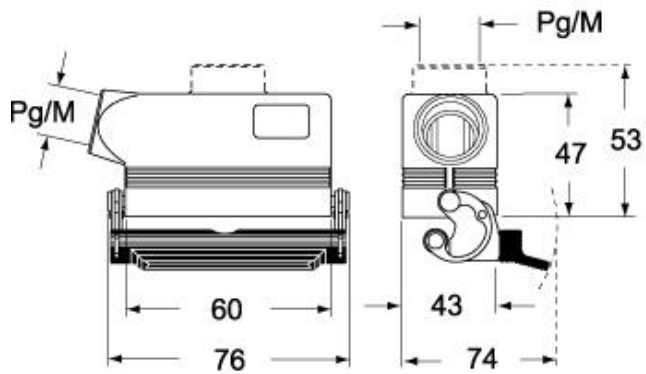

CHV LG (CAV LG), MHV LG (MAV LG) [MFV LG]

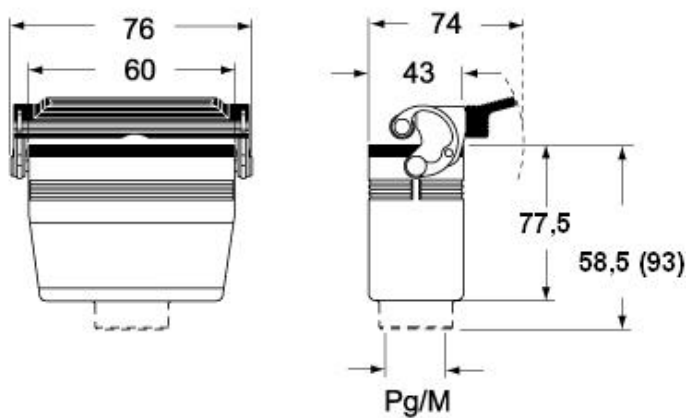

CHO L (CAO L) - MHO (MAO/MFO/MFV L) MHV L [MAV L]

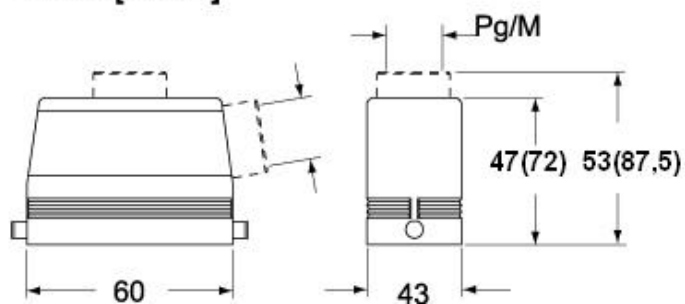

Notes

Dimensions shown in mm are not binding and may be changed without notice.