

Part number

# MHO 48 L32



Hood, C-TYPE series, with 2 pegs, M32 side cable entry, size "104.62"



#### Product description

<b>Product type</b>	Hood
<b>Series</b>	C-TYPE
<b>Closing type</b>	With 2 pegs
<b>Size</b>	Size 104.62
<b>Cable entry</b>	Side cable entry with adapter M32

#### Technical data

<b>IP degree of protection</b>	IP65 / IP66 / IP69
--------------------------------	--------------------

#### Further technical details

<b>Weight</b>	574,50 g
<b>Operating temperature range (min, max)</b>	-40°C...+125°C

#### Material properties

<b>Colour</b>	RAL 7040 grey
<b>RoHs conformity</b>	Compliant with exemption 6(c): copper alloy containing up to 4% lead by weight
<b>China RoHs - EFUP</b>	50
<b>REACH SVHC substances</b>	Yes Lead
<b>SCIP number</b>	15deaf78-e939-4401-a0b0-e2228ca32a03

#### Approvals / Standards

<b>Certifications</b>	DNV, BV
<b>UL</b>	ECBT2
<b>cUL</b>	ECBT8

#### General ordering information

<b>EAN13 code</b>	8015747053761
<b>eCl@ss 8.1</b>	27440202
<b>ETIM 7.0</b>	EC000437

#### Packaging Information

<b>Packaging length</b>	290,00 mm
<b>Packaging height</b>	140,00 mm
<b>Packaging width</b>	215,00 mm
<b>Packaging weight</b>	2,50 kg
<b>Packaging volume</b>	8,73 dm <sup>3</sup>
<b>Packaging description</b>	Carton box
<b>Packaging quantity</b>	4 Pcs
<b>Packaging EAN code</b>	8015747053778
<b>Sub-packaging weight</b>	0,63 kg
<b>Sub-packaging description</b>	Plastic packaging
<b>Sub-packaging quantity</b>	1 Pcs
<b>Sub-packaging EAN barcode</b>	8015747053785

Part number

# MHO 48 L32



Catalogue drawings

**CHO L - MHO L - MFO L**

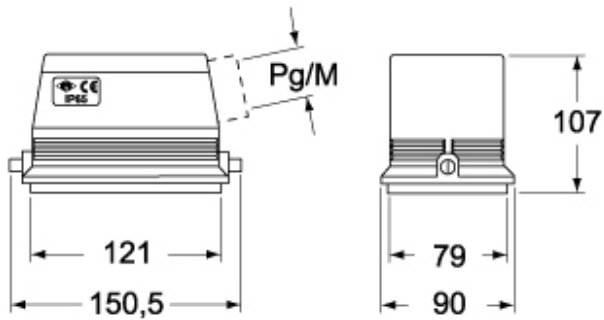

**CHV L - MHV L - MFV L**



## Notes

Dimensions shown in mm are not binding and may be changed without notice.