

Part number

# MGV 24.240 B



Hood, IP68 series, with 2 bayonets, M40 x 2 top cable entry, size "104.27"

#### Product description

<b>Product type</b>	Hood
<b>Series</b>	IP68
<b>Closing type</b>	With 2 bayonets
<b>Size</b>	Size 104.27
<b>Cable entry</b>	Top cable entry M40 x 2

#### Technical data

**IP degree of protection** IP65 / IP66 / IP69

#### Further technical details

<b>Weight</b>	535,00 g
<b>Operating temperature range (min, max)</b>	-40°C...+125°C

#### Material properties

<b>Main material</b>	Aluminium die-cast
<b>Other materials</b>	Bayonet: Stainless steel
<b>Colour</b>	RAL 9005 black
<b>RoHs conformity</b>	Compliant
<b>China RoHs - EFUP</b>	E
<b>REACH SVHC substances</b>	No

#### Approvals / Standards

<b>Certifications</b>	DNV, BV
<b>UL</b>	ECBT2
<b>cUL</b>	ECBT8

#### General ordering information

<b>EAN13 code</b>	8015747124140
<b>eCl@ss 8.1</b>	27440202
<b>ETIM 7.0</b>	EC000437

#### Packaging Information

<b>Packaging length</b>	205,00 mm
<b>Packaging height</b>	135,00 mm
<b>Packaging width</b>	135,00 mm
<b>Packaging weight</b>	1,19 kg
<b>Packaging volume</b>	3,74 dm <sup>3</sup>
<b>Packaging description</b>	Carton box
<b>Packaging quantity</b>	2 Pcs
<b>Packaging EAN code</b>	8015747124461
<b>Sub-packaging weight</b>	0,60 kg
<b>Sub-packaging description</b>	Plastic packaging
<b>Sub-packaging quantity</b>	1 Pcs
<b>Sub-packaging EAN barcode</b>	8015747124478

Part number

# MGV 24.240 B



Catalogue drawings

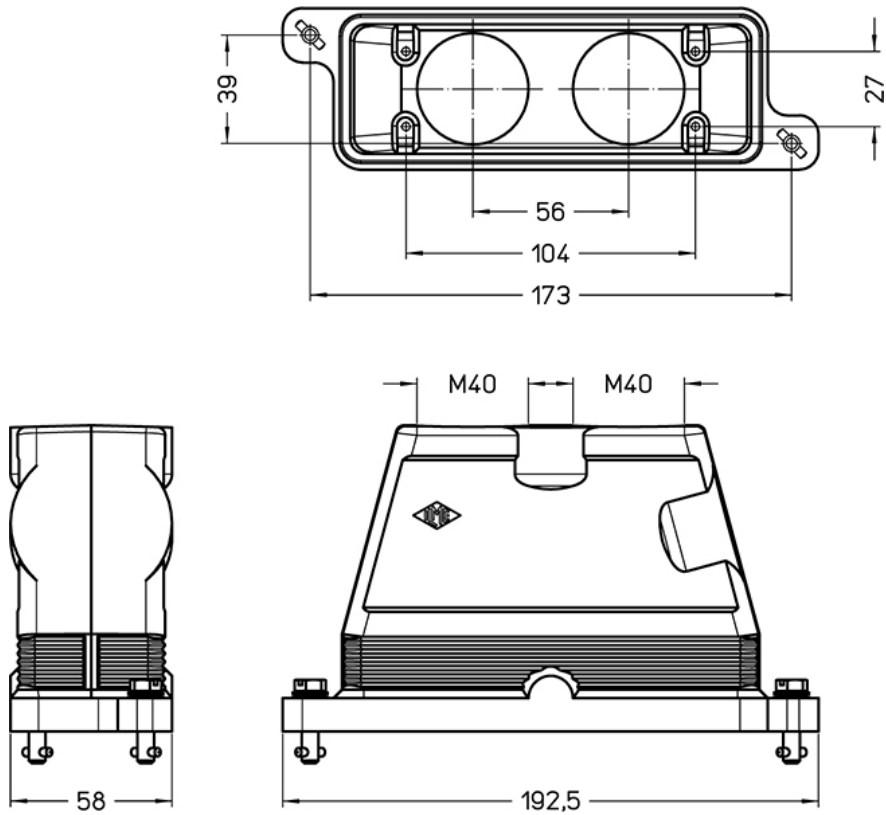

## Notes

Dimensions shown in mm are not binding and may be changed without notice.

---