

Part number

MFV 24.232



Hood, C-TYPE series, with 4 pegs, M32 x 2 double top cable entry without adapter, size "104.27", high construction

Product description

Product type	Hood
Series	C-TYPE
Closing type	With 4 pegs
Size	Size 104.27
Cable entry	Double top cable entry M32 x 2
Specification	High construction

Technical data

IP degree of protection IP65 / IP66 / IP69

Further technical details

Weight	288,00 g
Operating temperature range (min, max)	-40°C...+125°C

Material properties

Colour	RAL 7040 grey
RoHs conformity	Compliant
China RoHs - EFUP	E
REACH SVHC substances	No

Approvals / Standards

Certifications	DNV, BV
UL	ECBT2
cUL	ECBT8

General ordering information

EAN13 code	8015747115315
eCl@ss 8.1	27440202
ETIM 7.0	EC000437

Packaging Information

Sub-packaging weight	1,44 kg
Sub-packaging description	Plastic packaging
Sub-packaging quantity	5 Pcs
Sub-packaging EAN barcode	8015747115384

Part number

MFV 24.232



Catalogue drawings

CZAV L2 - (MZAV L2) - [MZFV L2]

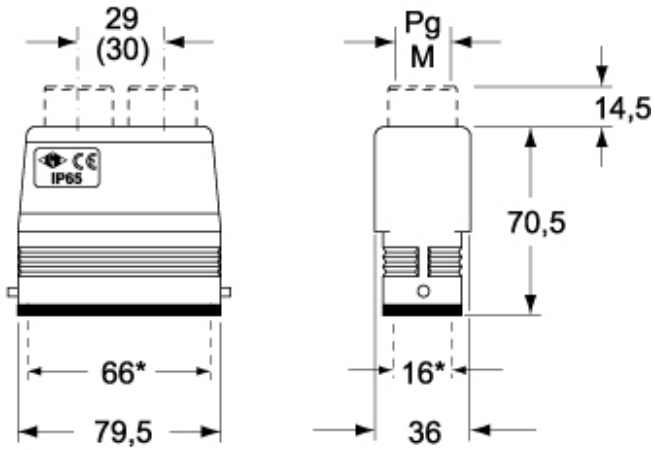

CAV - MAV - MFV

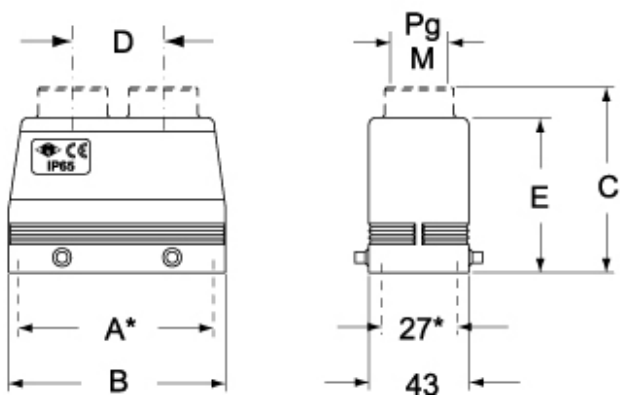

Notes

Dimensions shown in mm are not binding and may be changed without notice.