

Part number

# MAPS 16.32



Surface mounting housing, EMC series, with 2 levers, M32 cable entry, size "77.27", high construction

## Product description

<b>Product type</b>	Surface mounting housing
<b>Series</b>	EMC
<b>Closing type</b>	With 2 levers
<b>Size</b>	Size 77.27
<b>Cable entry</b>	With cable entry M32
<b>Specification</b>	High construction

## Technical data

<b>IP degree of protection</b>	IP65 / IP66 / IP69
--------------------------------	--------------------

## Further technical details

<b>Weight</b>	434,00 g
<b>Operating temperature range (min, max)</b>	-40°C...+125°C

## Material properties

<b>Other materials</b>	Lever: Stainless steel, polyamide (PA) Gasket: Conductive elastomer
<b>RoHs conformity</b>	Compliant
<b>China RoHs - EFUP</b>	E
<b>REACH SVHC substances</b>	No

## Approvals / Standards

<b>Certifications</b>	DNV, BV
<b>UL</b>	ECBT2
<b>cUL</b>	ECBT8

## General ordering information

<b>EAN13 code</b>	8015747127721
<b>eCl@ss 8.1</b>	27440202
<b>ETIM 7.0</b>	EC000437

## Packaging Information

<b>Packaging length</b>	475,00 mm
<b>Packaging height</b>	220,00 mm
<b>Packaging width</b>	175,00 mm
<b>Packaging weight</b>	4,40 kg
<b>Packaging volume</b>	18,29 dm <sup>3</sup>
<b>Packaging description</b>	Carton box
<b>Packaging quantity</b>	10 Pcs
<b>Packaging EAN code</b>	8015747248334
<b>Sub-packaging weight</b>	2,20 kg
<b>Sub-packaging description</b>	Plastic packaging
<b>Sub-packaging quantity</b>	5 Pcs
<b>Sub-packaging EAN barcode</b>	8015747248341

Part number

# MAPS 16.32



## Catalogue drawings

### CHIS

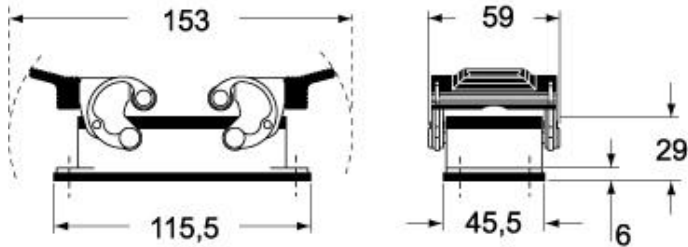

### CAPS - MAPS

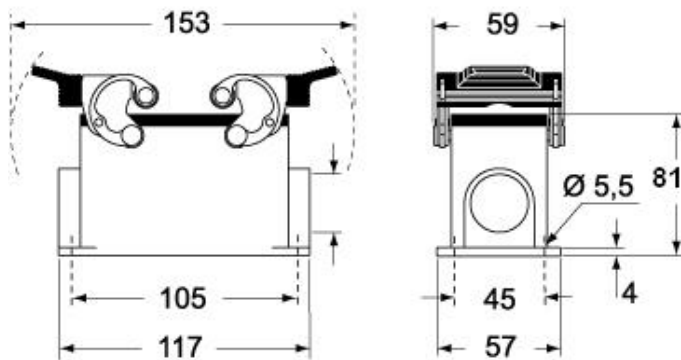

### CHCS



## Notes

Dimensions shown in mm are not binding and may be changed without notice.