

Part number

MAPR 16.32



Surface mounting housing, 180 °C series, with 2 levers, M32 cable entry, size "77.27", high construction

Product description

Product type	Surface mounting housing
Series	180 °C
Closing type	With 2 levers
Size	Size 77.27
Cable entry	With cable entry M32
Specification	High construction

Technical data

IP degree of protection IP65

Further technical details

Weight	400,00 g
Operating temperature range (min, max)	-40°C ... +180°C

Material properties

RoHS conformity	Compliant
China RoHS - EFUP	E
REACH SVHC substances	No
Approvals / Standards	
Certifications	DNV, BV
UL	ECBT2
cUL	ECBT8

General ordering information

EAN13 code	8015747101158
eCl@ss 8.1	27440202
ETIM 7.0	EC000437

Packaging Information

Packaging length	475,00 mm
Packaging height	220,00 mm
Packaging width	175,00 mm
Packaging weight	5,49 kg
Packaging volume	18,29 dm ³
Packaging description	Carton box
Packaging quantity	10 Pcs
Packaging EAN code	8015747248327
Sub-packaging weight	2,75 kg
Sub-packaging description	Plastic packaging
Sub-packaging quantity	5 Pcs
Sub-packaging EAN barcode	8015747101349

Part number

MAPR 16.32



Catalogue drawings

CHIR

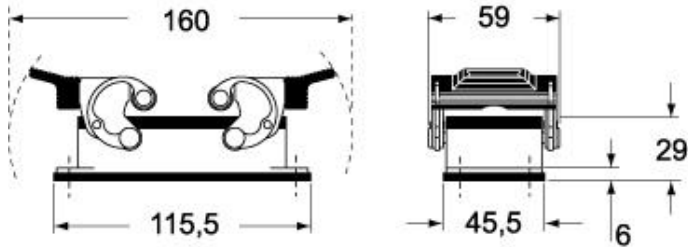

CAPR - MAPR

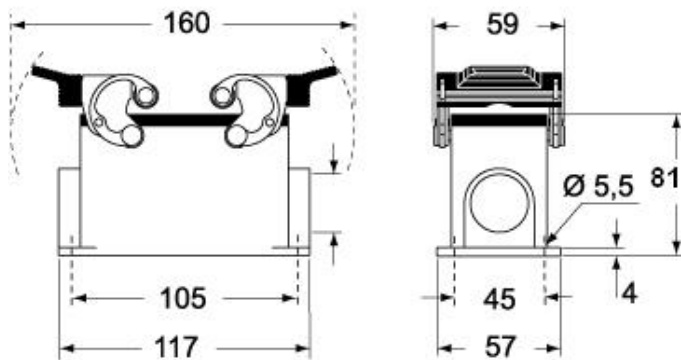

CHCR



Notes

Dimensions shown in mm are not binding and may be changed without notice.
