

Part number

MAO 24.40



Hood, C-TYPE series, with 4 pegs, M40 side cable entry, size "104.27", high construction



Product description

Product type	Hood
Series	C-TYPE
Closing type	With 4 pegs
Size	Size 104.27
Cable entry	Side cable entry M40
Specification	High construction

Technical data

IP degree of protection IP65 / IP66 / IP69

Further technical details

Weight	235,00 g
Operating temperature range (min, max)	-40°C...+125°C

Material properties

Colour	RAL 7040 grey
RoHs conformity	Compliant
China RoHs - EFUP	E
REACH SVHC substances	No

Approvals / Standards

Certifications	DNV, BV
UL	ECBT2
cUL	ECBT8

General ordering information

EAN13 code	8015747050708
eCl@ss 8.1	27440202
ETIM 7.0	EC000437

Packaging Information

Packaging length	255,00 mm
Packaging height	150,00 mm
Packaging width	180,00 mm
Packaging weight	2,35 kg
Packaging volume	6,89 dm ³
Packaging description	Carton box
Packaging quantity	10 Pcs
Packaging EAN code	8015747050715
Sub-packaging weight	1,18 kg
Sub-packaging description	Plastic packaging
Sub-packaging quantity	5 Pcs
Sub-packaging EAN barcode	8015747050722

Part number

MAO 24.40



Catalogue drawings

**CHO [CAO] CHV (CAV) - MHO [MAO]
MHV (MAV)**

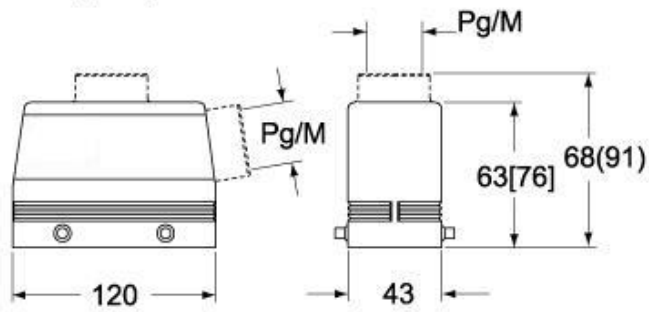

CHV G (CAV G) - MHV G (MAV G) - [MFV G]



Notes

Dimensions shown in mm are not binding and may be changed without notice.