

Part number

JCVP 16 L



Surface mounting housing, JEI®-V series, with 1 lever, Pg21 cable entry, size "77.27"

Product description		Material properties	
Product type	Surface mounting housing	Other materials	Lever: Galvanized steel Gasket: NBR
Series	JEI®-V	Colour	RAL 7040 grey
Closing type	With 1 lever	Approvals / Standards	
Size	Size 77.27	Certifications	DNV, BV
Cable entry	With cable entry Pg21	UL	ECBT2
Technical data		cUL	ECBT8
IP degree of protection	IP65 / IP66 / IP69	General ordering information	
Further technical details		EAN13 code	8015747137676
Weight	307,00 g	Packaging Information	
Operating temperature range (min, max)	-40°C...+125°C	Packaging length	208,00 mm
		Packaging height	140,00 mm
		Packaging width	290,00 mm
		Packaging weight	3,38 kg
		Packaging volume	8,44 dm ³
		Packaging description	Carton box
		Packaging quantity	10 Pcs
		Packaging EAN code	8015747144094
		Sub-packaging weight	1,69 kg
		Sub-packaging description	Plastic packaging
		Sub-packaging quantity	5 Pcs
		Sub-packaging EAN barcode	8015747140331

Part number

JCVP 16 L



Catalogue drawings

JCVP L

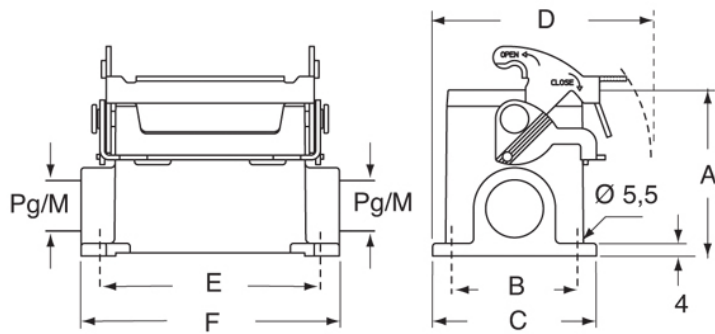

	A	B	C	D	E	F
JCVP 06 L	53	40	52	70	70	82
JCVP 10 L	57	40	52	73	82	93,5
JCVP 16 L	63	45	57	75,5	105	117
JCVP 24 L	63	45	57	75,5	132	144

Notes

Dimensions shown in mm are not binding and may be changed without notice.