

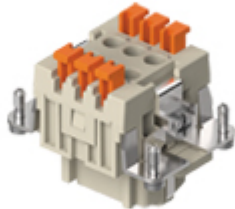

Part number

CSHF 06 S



Female insert, CSH S series, SQUICH® spring terminal connection without tools, 6 poles + PE, 16 A 500 V 6 kV 3, size "44.27"

Product description

Product type	Insert
Series	CSH S
Connection type	SQUICH® spring terminal connection without tools
Gender	Female
N. of poles	6 poles + 
Size	Size 44.27

Technical data

Current	16 A
Voltage	500 V
Rated impulse withstand voltage	6 kV
Pollution degree	3
Rated voltage according to UL/CSA	600 V
Wire cross-section	0,14 mm ² - 2,50 mm ²
AWG size	26 - 14
Contact type	Stamped silver plated
IP degree of protection	IP20 without enclosure, IP65/IP66/IP68/IP69 with enclosure

Further technical details

Characteristics according to EN 61984	16A 500V 6kV 3
Mating cycles	≥ 500
Insulation resistance	≥ 10 GΩ
Contact resistance	≤ 3 mΩ
Weight	46,00 g
Operating temperature range (min, max)	-40 °C ... +125 °C
Conductors stripping length	9...11 mm
UL 94 flammability rating	V-0

Material properties

Main material	Polycarbonate (PC)
Other materials	Contacts: copper alloy
Colour	RAL 7032 grey
RoHs conformity	Compliant
China RoHs - EFUP	E
REACH SVHC substances	No

Approvals / Standards

UL	ECBT2
cUL	ECBT8

General ordering information

EAN13 code	8015747265867
eCl@ss 8.1	27440205
ETIM 7.0	EC000438

Packaging Information

Packaging length	245,00 mm
Packaging height	165,00 mm
Packaging width	215,00 mm
Packaging weight	3,27 kg
Packaging volume	8,69 dm ³
Packaging description	Carton box
Packaging quantity	60 Pcs
Packaging EAN code	8015747265942
Sub-packaging length	197,00 mm
Sub-packaging height	44,00 mm
Sub-packaging width	113,00 mm
Sub-packaging weight	0,55 kg
Sub-packaging volume	0,98 dm ³
Sub-packaging description	Carton tray
Sub-packaging quantity	10 Pcs
Sub-packaging EAN barcode	8015747265959

Part number

CSHF 06 S



Catalogue drawings

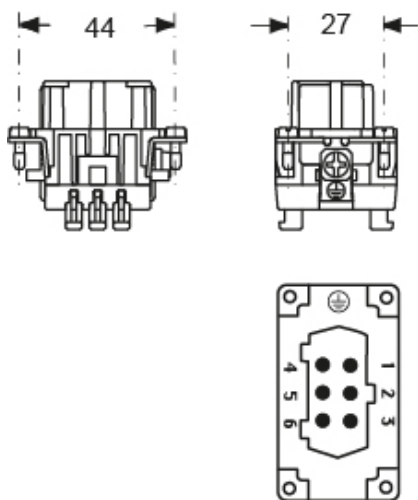

Derating curves

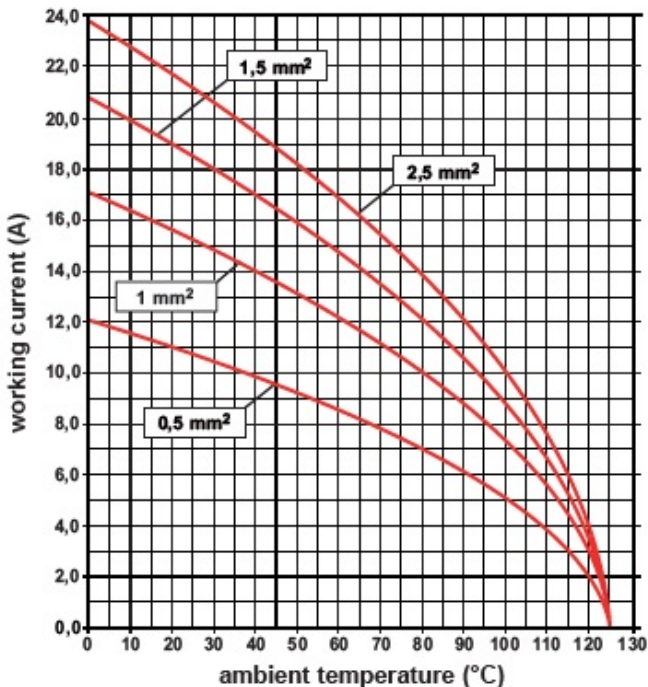

Notes

Dimensions shown in mm are not binding and may be changed without notice.

California Proposition 65 Information



WARNING

This product can expose you to nickel compounds, known to the State of California to cause cancer and/or reproductive toxicity. For more information go to www.P65Warnings.ca.gov.

California Proposition 65 Information



WARNING

This product can expose you to lead and its compounds, known to the State of California to cause cancer and/or reproductive toxicity. For more information go to www.P65Warnings.ca.gov.

SQUICH® connection with actuator button



Reopening
