

Part number

CR 50 AD2



Adapter plate, size "77.27", for two 50 poles D-SUB inserts

Product description

Product type	Adapter plate
Size	Size 77.27
Specification	For two 50 poles D-SUB inserts

Further technical details

Weight	5,70 g
---------------	--------

General ordering information

EAN13 code	8015747037884
eCl@ss 8.1	27440201
ETIM 7.0	EC002309

Packaging Information

Sub-packaging weight	0,06 kg
Sub-packaging description	Carton box
Sub-packaging quantity	10 Pcs
Sub-packaging EAN barcode	8015747037891

Part number

CR 50 AD2



Catalogue drawings

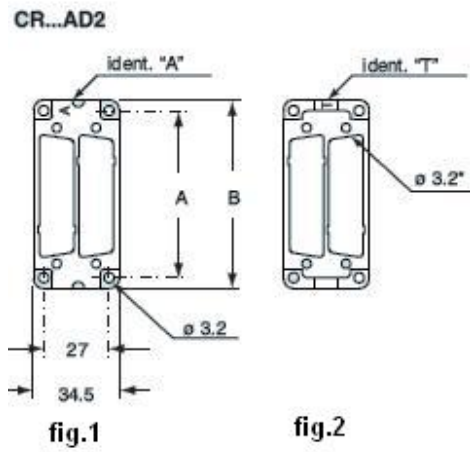

Notes

The electrical continuity is guaranteed only if mounted in our enclosures.

Dimensions shown in mm are not binding and may be changed without notice.