

Part number

CR 50 AD1

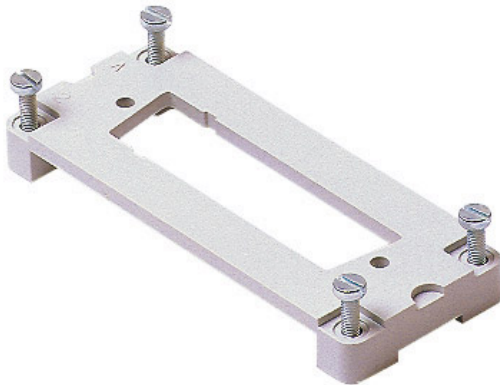

Adapter plate, size "77.27", for one 50 poles D-SUB insert

Product description

Product type	Adapter plate
Size	Size 77.27
Specification	For one 50 poles D-SUB insert

Further technical details

Weight	8,00 g
---------------	--------

General ordering information

EAN13 code	8015747037860
eCl@ss 8.1	27440201
ETIM 7.0	EC002309

Packaging Information

Sub-packaging weight	0,08 kg
Sub-packaging description	Carton box
Sub-packaging quantity	10 Pcs
Sub-packaging EAN barcode	8015747037877

Part number

CR 50 AD1



Catalogue drawings

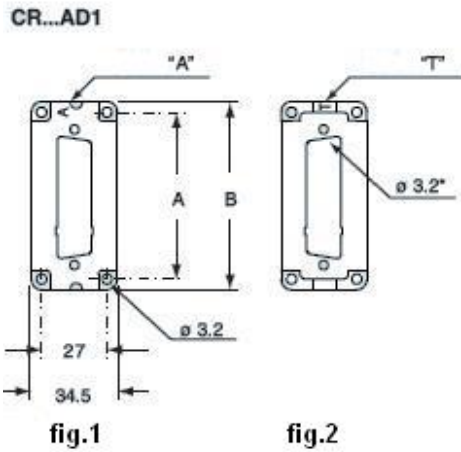

Notes

The electrical continuity is guaranteed only if mounted in our enclosures.

Dimensions shown in mm are not binding and may be changed without notice.