

Part number

CR 15 AD2



Adapter plate, size "44.27", for two 15 poles D-SUB inserts

Product description

| | |
|----------------------|--------------------------------|
| Product type | Adapter plate |
| Size | Size 44.27 |
| Specification | For two 15 poles D-SUB inserts |

Further technical details

| | |
|---------------|--------|
| Weight | 4,00 g |
|---------------|--------|

General ordering information

| | |
|-------------------|---------------|
| EAN13 code | 8015747037587 |
| eCl@ss 8.1 | 27440201 |
| ETIM 7.0 | EC002309 |

Packaging Information

| | |
|----------------------------------|---------------|
| Sub-packaging weight | 0,04 kg |
| Sub-packaging description | Carton box |
| Sub-packaging quantity | 10 Pcs |
| Sub-packaging EAN barcode | 8015747037594 |

Part number

CR 15 AD2



Catalogue drawings

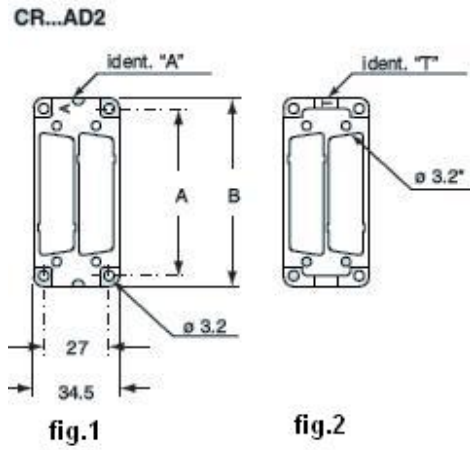

Notes

The electrical continuity is guaranteed only if mounted in our enclosures.

Dimensions shown in mm are not binding and may be changed without notice.