

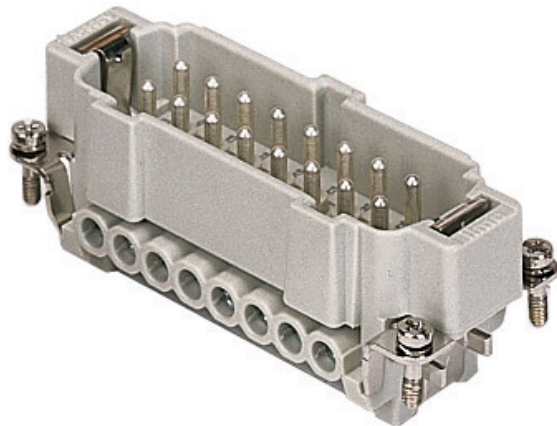

Part number

# CNEM 16 TXN



Male insert, CNE series, screw terminal connection, 16 poles + PE (17-32), 16 A 500 V 6 kV 3, size "77.62", without plate

## Product description

<b>Product type</b>	Insert
<b>Series</b>	CNE
<b>Connection type</b>	Screw terminal connection
<b>Gender</b>	Male
<b>N. of poles</b>	32 poles + 
<b>Size</b>	Size 77.62
<b>Specification</b>	Without plate, for prepared conductors

## Technical data

<b>Current</b>	16 A
<b>Voltage</b>	500 V
<b>Rated impulse withstand voltage</b>	6 kV
<b>Pollution degree</b>	3
<b>Rated voltage according to UL/CSA</b>	600 V
<b>Wire cross-section</b>	0,25 mm <sup>2</sup> - 2,50 mm <sup>2</sup>
<b>AWG size</b>	24 - 14
<b>Contact type</b>	Turned silver plated
<b>Pole numbering system</b>	17-32
<b>IP degree of protection</b>	IP20 without enclosure, IP65/IP66 with enclosure

## Further technical details

<b>Characteristics according to EN 61984</b>	16A 500V 6kV 3; 16A 400/690V 6kV 2
<b>Mating cycles</b>	≥ 500
<b>Insulation resistance</b>	≥ 10 GΩ
<b>Contact resistance</b>	≤ 1 mΩ
<b>Weight</b>	81,40 g
<b>Operating temperature range (min, max)</b>	-40 °C ... +125 °C
<b>Conductors stripping length</b>	7 mm
<b>UL 94 flammability rating</b>	V-0
<b>Torque for main contact</b>	M3: 0,5 Nm; 4,4 lb.in (Ph0 or 0,8 x 4 mm)

## Material properties

<b>Main material</b>	Polycarbonate (PC)
<b>Other materials</b>	Contacts: copper alloy
<b>Colour</b>	RAL 7032 grey
<b>RoHs conformity</b>	Compliant with exemption 6(c): copper alloy containing up to 4% lead by weight
<b>China RoHs - EFUP</b>	50
<b>REACH SVHC substances</b>	Yes Lead
<b>SCIP number</b>	1a9c93ff-0445-4a16-81e3-1609ac5274d6

## Approvals / Standards

<b>Reference standard</b>	EN 61984:2009-06
<b>Certifications</b>	CSA, CQC, DNV, BV, EAC
<b>UL</b>	ECBT2, PVVA2
<b>cUL</b>	ECBT8, PVVA8

## General ordering information

<b>EAN13 code</b>	8015747033152
<b>eCl@ss 8.1</b>	27440205
<b>ETIM 7.0</b>	EC000438

## Packaging Information

<b>Packaging length</b>	230,00 mm
<b>Packaging height</b>	110,00 mm
<b>Packaging width</b>	180,00 mm
<b>Packaging weight</b>	2,76 kg
<b>Packaging volume</b>	4,55 dm <sup>3</sup>
<b>Packaging description</b>	Carton box
<b>Packaging quantity</b>	30 Pcs
<b>Packaging EAN code</b>	8015747033169
<b>Sub-packaging length</b>	87,00 mm
<b>Sub-packaging height</b>	36,00 mm
<b>Sub-packaging width</b>	180,00 mm
<b>Sub-packaging weight</b>	0,46 kg
<b>Sub-packaging volume</b>	0,56 dm <sup>3</sup>
<b>Sub-packaging description</b>	Carton tray
<b>Sub-packaging quantity</b>	5 Pcs
<b>Sub-packaging EAN barcode</b>	8015747033176

Part number

# CNEM 16 TXN



Catalogue drawings

Catalogue drawings

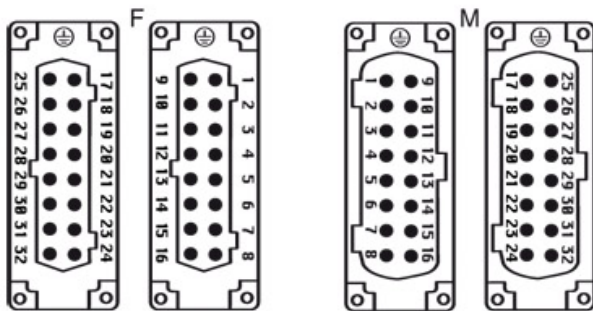
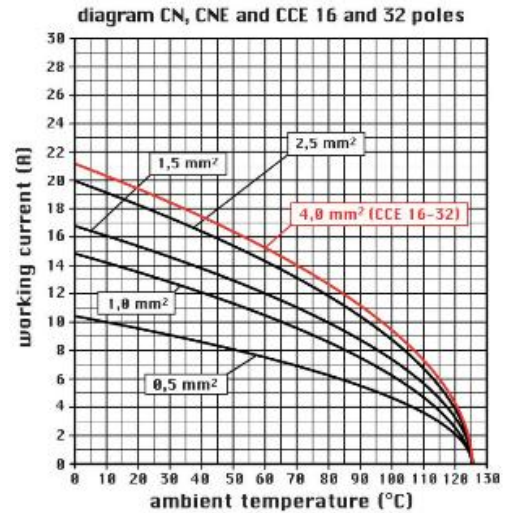
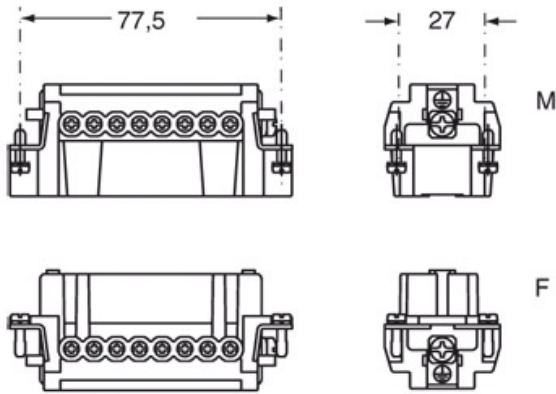

## Notes

CNEF/M 16 TN/TXN inserts:

- characteristics according to EN 61984:  
(16A 500V 6kV 3)  
(16A 400/690V 6kV 2)
- rated voltage according to UL/CSA: 600V
- insulation resistance: > 10 GOhm
- ambient temperature limit: -40 °C ... +125 °C
- are made of self-extinguishing thermoplastic resin UL 94 V0
- mechanical life: > 500 cycles
- contact resistance: < 1 mOhm
- enclosures: size "77.62":

C-TYPE IP65/IP66  
W-TYPE aggressive environments

Dimensions shown in mm are not binding and may be changed without notice.

CNE ... : for non-prepared conductors



CNE ... X : for conductors with bush terminal

---

### California Proposition 65 Information



### WARNING

This product can expose you to lead and its compounds, known to the State of California to cause cancer and/or reproductive toxicity. For more information go to [www.P65Warnings.ca.gov](http://www.P65Warnings.ca.gov).

---

### California Proposition 65 Information



### WARNING

This product can expose you to lead and its compounds, known to the State of California to cause cancer and/or reproductive toxicity. For more information go to [www.P65Warnings.ca.gov](http://www.P65Warnings.ca.gov).

---