

Part number

# CAO 10 X



Hood, C-TYPE series, with 2 levers, Pg21 side cable entry, size "57.27", high construction, without gasket

#### Product description

<b>Product type</b>	Hood
<b>Series</b>	C-TYPE
<b>Closing type</b>	With 2 levers
<b>Size</b>	Size 57.27
<b>Cable entry</b>	Side cable entry Pg21
<b>Specification</b>	High construction, without gasket

#### Technical data

<b>IP degree of protection</b>	IP65 / IP66 / IP69
--------------------------------	--------------------

#### Further technical details

<b>Weight</b>	261,00 g
<b>Operating temperature range (min, max)</b>	-40°C...+125°C

#### Material properties

<b>Other materials</b>	Lever: Stainless steel, polyamide (PA)
<b>Colour</b>	RAL 7040 grey
<b>RoHs conformity</b>	Compliant
<b>China RoHs - EFUP</b>	E
<b>REACH SVHC substances</b>	No

#### Approvals / Standards

<b>Certifications</b>	DNV, BV
<b>UL</b>	ECBT2
<b>cUL</b>	ECBT8

#### General ordering information

<b>EAN13 code</b>	8015747006149
-------------------	---------------

#### Packaging Information

<b>Packaging length</b>	290,00 mm
<b>Packaging height</b>	140,00 mm
<b>Packaging width</b>	215,00 mm
<b>Packaging weight</b>	2,92 kg
<b>Packaging volume</b>	8,73 dm <sup>3</sup>
<b>Packaging description</b>	Carton box
<b>Packaging quantity</b>	10 Pcs
<b>Packaging EAN code</b>	8015747215558
<b>Sub-packaging weight</b>	1,46 kg
<b>Sub-packaging description</b>	Plastic packaging
<b>Sub-packaging quantity</b>	5 Pcs
<b>Sub-packaging EAN barcode</b>	8015747006156

Part number

# CAO 10 X



Catalogue drawings

**CHO X (CAO X) - MHO X (MAO X)**

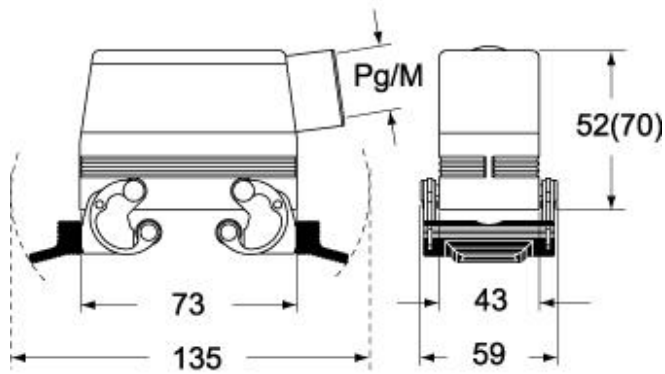

**CHV X (CAV X) - MHV X (MAV X)**



## Notes

Dimensions shown in mm are not binding and may be changed without notice.