

Part number

AS M32P



Complete cable gland, M32, for diameter
15-24 mm

Product description

Product type	Complete cable gland
Cable entry	M32
Specification	For diameter 15-24 mm

Technical data

IP degree of protection	IP68
--------------------------------	------

Further technical details

Weight	139,00 g
Operating temperature range (min, max)	-25°C ... +120°C

General ordering information

EAN13 code	8015747132589
-------------------	---------------

Packaging Information

Sub-packaging length	197,00 mm
Sub-packaging height	44,00 mm
Sub-packaging width	113,00 mm
Sub-packaging weight	1,39 kg
Sub-packaging volume	0,98 dm ³
Sub-packaging description	Carton tray
Sub-packaging quantity	10 Pcs
Sub-packaging EAN barcode	8015747133609

Part number

AS M32P



Catalogue drawings

AS C..P - AS M..P

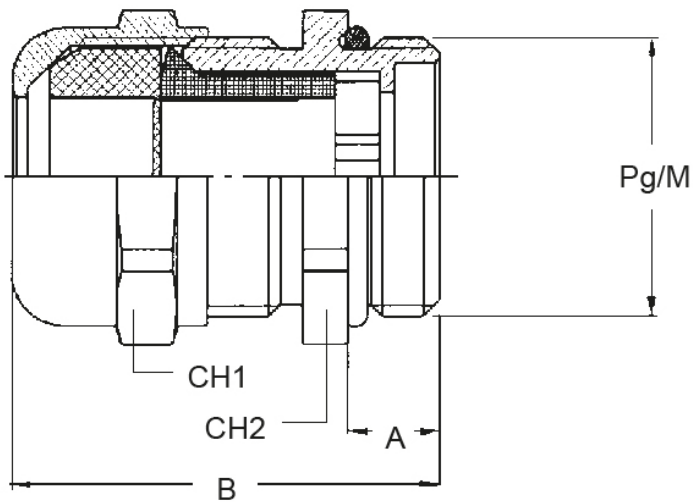

AS C..P	A	B	CH1	CH2
11	6	26	20	20
13,5	6,5	28	22	22
16	6,5	30	24	24
21	7	35	30	30
29	8	43	40	40
36	9	50	50	50
42	10	57	58	58

AS M..P	A	B	CH1	CH2
20	7	29	22	22
25	8	37	30	30
32	8,5	45	40	40
40	8,5	45	40	42
50	9,5	51	50	55

Notes

Dimensions shown in mm are not binding and may be changed without notice.
