

Artikelnummer

# PEW 16123 SM



## Produktbeschreibung

<b>Produkttyp</b>	Stecker Wand
<b>Baureihe</b>	PEW...SM, PLUSO
<b>Polzahl</b>	2 polig + 
<b>Position des Schutzleiters</b>	12

## Technische Daten

<b>Strom</b>	16 A
<b>Spannung</b>	ins. transformer
<b>IP-Schutzart</b>	IP67

## Weitere technische Details

<b>Betriebstemperatur (min., max.)</b>	-25°C ... +40°C
--	-----------------

## Materialeigenschaften

<b>Farbe</b>	RAL 7035 lichtgrau, RAL 9010 reinweiß
--------------	---------------------------------------

## Zulassungen / Standards

<b>Bezugsnorm</b>	EN 60309-1 und -2
-------------------	-------------------

## Allgemeine Bestellinformationen

<b>EAN-Code 13</b>	8015747156622
--------------------	---------------

Artikelnummer

# PEW 16123 SM



Zeichnungen aus dem Katalog

(16 / 32A) PEW ... SM

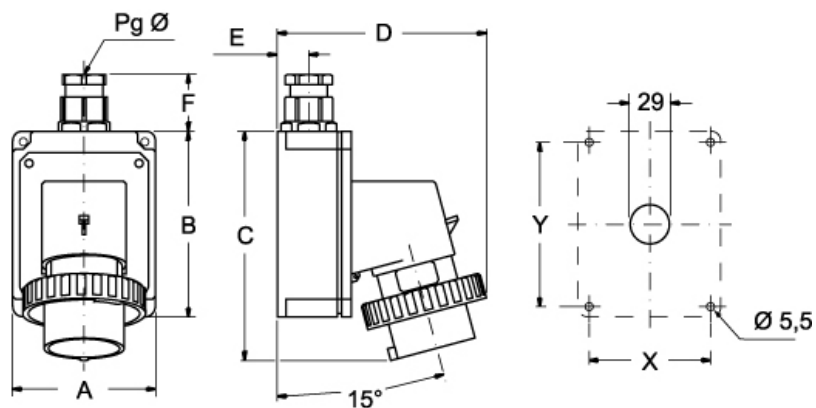

PEW ... SM		A	B	C	D	E	F	X	Y	Pg Ø
<b>16A</b>	2P+⊕	75	115	144	126	19	35	65	105	16
	3P+⊕	75	115	144	134	19	35	65	105	16
	3P+N+⊕	100	130	164	145	22	42	85	115	21
<b>32A</b>	2P+⊕	100	130	178	154	22	42	85	115	21
	3P+⊕	100	130	178	154	22	42	85	115	21
	3P+N+⊕	100	130	178	160	22	42	85	115	21

## Hinweise

Die angegebenen Abmessungen in mm sind nicht verbindlich.  
Technische Änderungen bleiben vorbehalten.