

Part number

TM 1663 SIT



Interlocked switched socket-outlet, TM series,
2 poles + PE, 6 h (blue), 16 A, 200 ÷ 250 V,
E16 fuse carrier, without base box

Product description

Product type	Interlocked switched socket-outlet
Series	TM.. SIT
N. of poles	2 poles + 
Clock position	6
Size	114 x 255 mm fixing distance, for assembly in single or multiple boxes
Specification	E16 fuse carrier Without base box

Technical data

Current	16 A
Voltage	200 ÷ 250 V
IP degree of protection	IP66 / IP67

Further technical details

Weight	1.160,00 g
Operating temperature range (min, max)	-25°C ... +40°C
UL 94 flammability rating	V-2
IK rating (impact degree of protection)	IK10

Material properties

Colour	RAL 7012 grey, RAL 5015 blue
RoHs conformity	Compliant with exemption 6(c): copper alloy containing up to 4% lead by weight
China RoHs - EFUP	50
REACH SVHC substances	Yes Lead
SCIP number	Ce861c8d-b979-403b-96d9-80aef6dc281d

Approvals / Standards

Reference standard	EN 60309-1, -2 e -4
---------------------------	---------------------

General ordering information

EAN13 code	8015747089906
-------------------	---------------

Packaging Information

Packaging weight	10,44 kg
Packaging volume	52,36 dm ³
Packaging description	Carton box
Packaging quantity	9 Pcs
Packaging EAN code	8015747089913
Sub-packaging length	95,00 mm
Sub-packaging height	40,00 mm
Sub-packaging width	253,00 mm
Sub-packaging weight	1,16 kg
Sub-packaging volume	0,96 dm ³
Sub-packaging description	Carton tray
Sub-packaging quantity	1 Pcs
Sub-packaging EAN barcode	8015747089920

Part number

TM 1663 SIT



Catalogue drawings

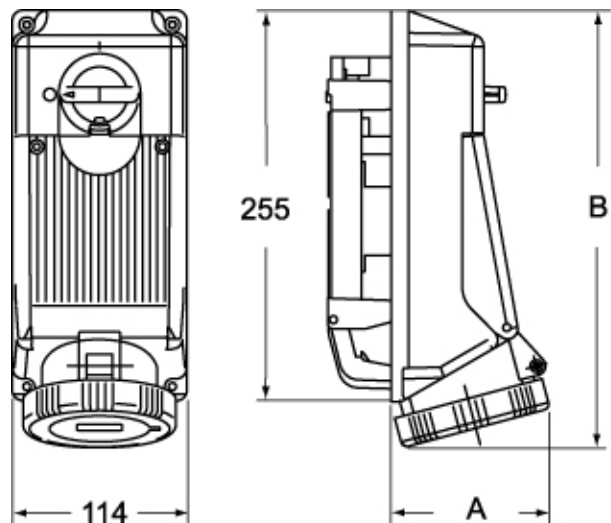

	A	B
2P+⊕	83	276
3P+⊕	85	276
3P+N+⊕	90	277