

Part number

# SQV 3244.5



Interlocked switched socket-outlet, SQV series, 3 poles + PE, 4 h (yellow), 32 A, 100 ÷ 130 V, sectionable fuse carrier 10 x 38 mm

#### Product description

<b>Product type</b>	Interlocked switched socket-outlet
<b>Series</b>	SQV
<b>N. of poles</b>	3 poles + 
<b>Clock position</b>	4
<b>Size</b>	Socket fixing centre distance 88 x 230 mm
<b>Specification</b>	Sectionable fuse carrier 10 x 38 mm

#### Technical data

<b>Current</b>	32 A
<b>Voltage</b>	100 ÷ 130 V
<b>IP degree of protection</b>	IP55

#### Further technical details

<b>Weight</b>	725,00 g
<b>Operating temperature range (min, max)</b>	-25°C ... +40°C
<b>IK rating (impact degree of protection)</b>	IK08

#### Material properties

<b>Colour</b>	RAL 7035 grey, RAL 1021 yellow
<b>RoHs conformity</b>	Compliant with exemption 6(c): copper alloy containing up to 4% lead by weight
<b>China RoHs - EFUP</b>	50
<b>REACH SVHC substances</b>	Yes Lead
<b>SCIP number</b>	F6799547-ab84-42f2-938f-233ba663766d

#### Approvals / Standards

<b>Reference standard</b>	EN 60309-1, -2 e -4
---------------------------	---------------------

#### General ordering information

<b>EAN13 code</b>	8015747088428
-------------------	---------------

#### Packaging Information

<b>Sub-packaging length</b>	116,00 mm
<b>Sub-packaging height</b>	103,00 mm
<b>Sub-packaging width</b>	230,00 mm
<b>Sub-packaging weight</b>	0,73 kg
<b>Sub-packaging volume</b>	2,75 dm <sup>3</sup>
<b>Sub-packaging description</b>	Carton box
<b>Sub-packaging quantity</b>	1 Pcs
<b>Sub-packaging EAN barcode</b>	8015747088435

Part number

# SQV 3244.5



Catalogue drawings

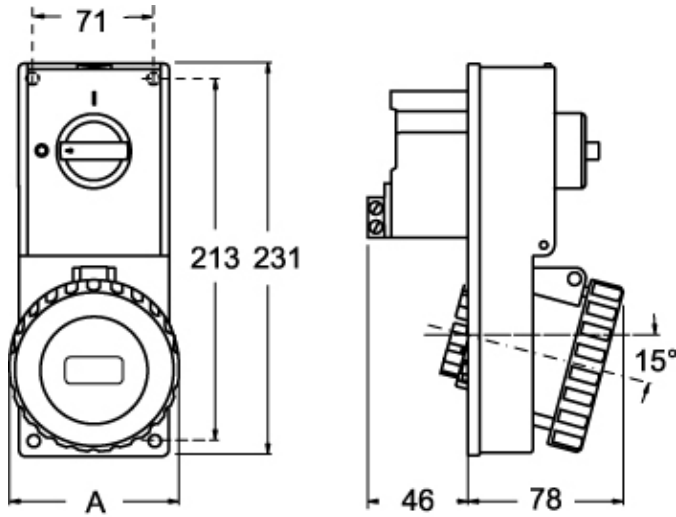

Catalogue drawings

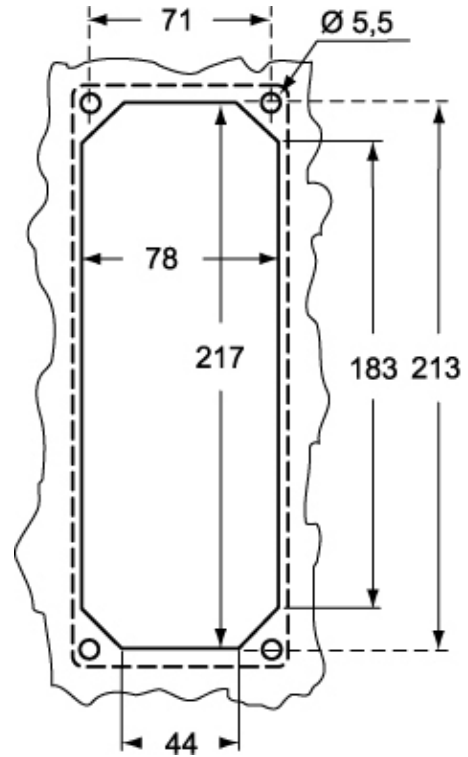

SQV.5		A
32A	2P+⊕	92
	3P+⊕	92
	3P+N+⊕	100