

Part number

SQE 1663



Interlocked switched socket-outlet, SQE series, 2 poles + PE, 6 h (blue), 16 A, 200 ÷ 250 V, without fuse-carrier

Product description

Product type	Interlocked switched socket-outlet
Series	SQE
N. of poles	2 poles + 
Clock position	6
Size	Socket fixing centre distance 88 x 230 mm
Specification	Without fuse-carrier

Technical data

Current	16 A
Voltage	200 ÷ 250 V
IP degree of protection	IP44

Further technical details

Weight	468,00 g
Operating temperature range (min, max)	-25°C ... +40°C
IK rating (impact degree of protection)	IK08

Material properties

Colour	RAL 7035 grey, RAL 5015 blue
RoHs conformity	Compliant with exemption 6(c): copper alloy containing up to 4% lead by weight
China RoHs - EFUP	50
REACH SVHC substances	Yes Lead
SCIP number	Ce861c8d-b979-403b-96d9-80aef6dc281d

Approvals / Standards

Reference standard	EN 60309-1, -2 e -4
---------------------------	---------------------

General ordering information

EAN13 code	8015747085595
-------------------	---------------

Packaging Information

Packaging length	290,00 mm
Packaging height	250,00 mm
Packaging width	360,00 mm
Packaging weight	4,71 kg
Packaging volume	26,10 dm ³
Packaging description	Carton box
Packaging quantity	9 Pcs
Packaging EAN code	8015747085601
Sub-packaging weight	0,52 kg
Sub-packaging description	Plastic packaging
Sub-packaging quantity	1 Pcs
Sub-packaging EAN barcode	8015747085618

Part number

SQE 1663



Catalogue drawings

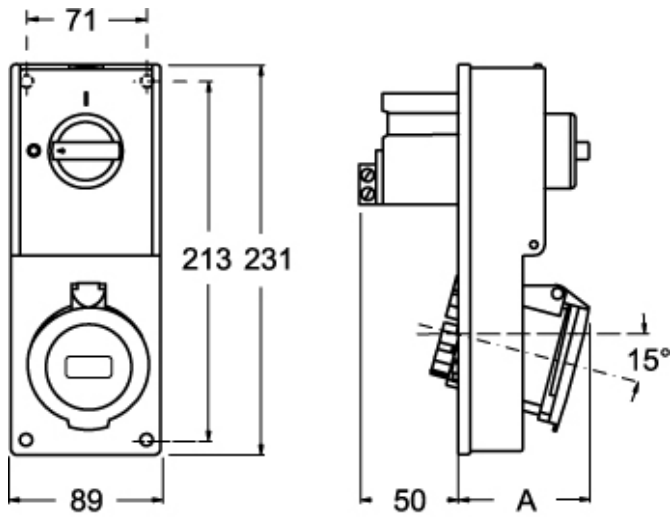

Catalogue drawings



SQE		A
16A	2P+⊕	64
	3P+⊕	65
	3P+N+⊕	67