

Part number

SIF3D 0.2R

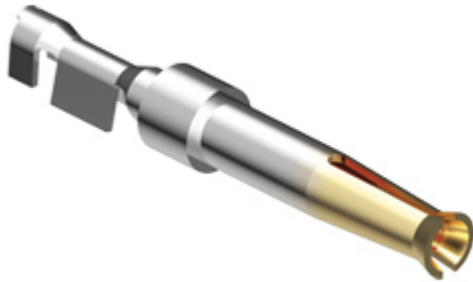

Female crimp contact, SI series, 5 A, stamped gold plated, wire cross section 0,08 - 0,21 mm², AWG 28 - 24, reel packaging, for 50 mating cycles

Product description

| | |
|----------------------|--|
| Product type | Crimp contact |
| Series | SI |
| Gender | Female |
| Specification | Reel packaging For 50 mating cycles |

Technical data

| | |
|---------------------------|---|
| Current | 5 A |
| Wire cross-section | 0,08 mm ² - 0,21 mm ² |
| AWG size | 28 - 24 |
| Contact type | Stamped gold plated |

Further technical details

| | |
|------------------------------------|---------|
| Contact resistance | ≤ 10 mΩ |
| Weight | 0,19 g |
| Conductors stripping length | 3 mm |

Material properties

| | |
|------------------------------|-----------|
| RoHS conformity | Compliant |
| China RoHS - EFUP | E |
| REACH SVHC substances | No |

Approvals / Standards

| | |
|-----------------------|-------|
| Certifications | EAC |
| UL | ECBT2 |
| cUL | ECBT8 |

General ordering information

| | |
|-------------------|---------------|
| EAN13 code | 8015747276986 |
| eCl@ss 8.1 | 27440204 |
| ETIM 7.0 | EC000796 |

Packaging Information

| | |
|------------------------------|---------------|
| Packaging weight | 2,15 kg |
| Packaging description | Plastic bag |
| Packaging quantity | 10000 Pcs |
| Packaging EAN code | 8015747188029 |

Part number

SIF3D 0.2R



Catalogue drawings

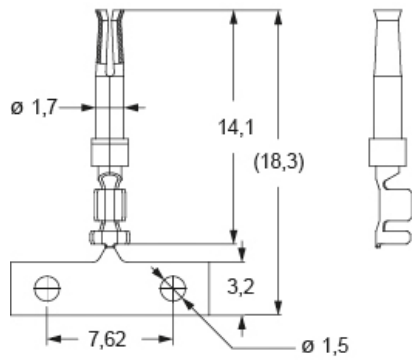

SIF..D R

Reel unrolling left

