

Part number

# MMAV 03 X32



Hood, 830V series, with 2 levers, M32 top cable entry, size "57.27", high construction, without gasket

Product description		Material properties	
<b>Product type</b>	Hood	<b>Colour</b>	RAL 7040 grey
<b>Series</b>	830V	<b>RoHS conformity</b>	Compliant
<b>Closing type</b>	With 2 levers	<b>China RoHS - EFUP</b>	E
<b>Size</b>	Size 57.27	<b>REACH SVHC substances</b>	No
<b>Cable entry</b>	Top cable entry M32	<b>Approvals / Standards</b>	
<b>Specification</b>	High construction, without gasket	<b>Certifications</b>	DNV, BV
<b>Technical data</b>		<b>UL</b>	ECBT2
<b>IP degree of protection</b>	IP65 / IP66 / IP69	<b>cUL</b>	ECBT8
<b>Further technical details</b>		<b>General ordering information</b>	
<b>Weight</b>	274,00 g	<b>EAN13 code</b>	8015747057950
<b>Operating temperature range (min, max)</b>	-40°C...+125°C	<b>Packaging Information</b>	
		<b>Sub-packaging weight</b>	1,37 kg
		<b>Sub-packaging description</b>	Plastic packaging
		<b>Sub-packaging quantity</b>	5 Pcs
		<b>Sub-packaging EAN barcode</b>	8015747106740

Part number

# MMAV 03 X32



Catalogue drawings

**CMO X (CMAO X) - MMO X (MMAO X)**

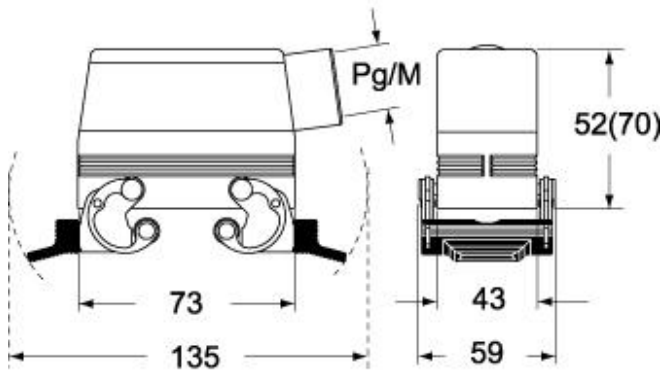

**CMV X (CMAV X) - MMV X (MMAV X)**

