

Part number

MMAP 16.240



Surface mounting housing, 830V series, with 2 levers, M40 x 2 cable entry, size "104.27", high construction



Product description		Material properties	
Product type	Surface mounting housing	Colour	RAL 7040 grey
Series	830V	RoHs conformity	Compliant
Closing type	With 2 levers	China RoHs - EFUP	E
Size	Size 104.27	REACH SVHC substances	No
Cable entry	With cable entry M40 x 2	Approvals / Standards	
Specification	High construction	Certifications	DNV, BV
Technical data		UL	ECBT2
IP degree of protection	IP65 / IP66 / IP69	cUL	ECBT8
Further technical details		General ordering information	
Weight	455,00 g	EAN13 code	8015747057790
Operating temperature range (min, max)	-40°C...+125°C	Packaging Information	
		Sub-packaging weight	2,28 kg
		Sub-packaging description	Plastic packaging
		Sub-packaging quantity	5 Pcs
		Sub-packaging EAN barcode	8015747057806

Part number

MMAP 16.240



Catalogue drawings

CMP CMAP - MMP MMAP

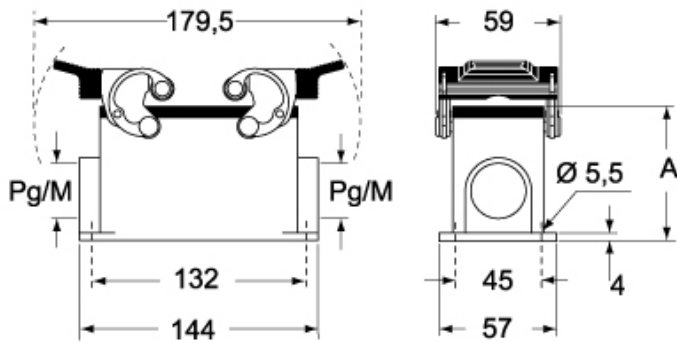

CMP CS/CP CMAP CS/CP - MMP CS/CP MMAP CS/CP



	A
CMP / MMP	63
CMAP / MMAP	80
CMP CS / MMP CS	63
CMAP CS / MMAP CS	80
CMP CP / MMP CP	63
CMAP CP / MMAP CP	80