

Part number

MMAP 16 CP32



Surface mounting housing, 830V series, with 4 pegs, M32 cable entry, size "104.27", high construction, with plastic cover

Product description	
Product type	Surface mounting housing
Series	830V
Closing type	With 4 pegs
Size	Size 104.27
Cable entry	With cable entry M32
Specification	High construction, with plastic cover
Technical data	
IP degree of protection	IP65
Further technical details	
Operating temperature range (min, max)	-40°C...+125°C

Material properties	
Colour	RAL 7040 grey
RoHs conformity	Compliant
China RoHs - EFUP	E
REACH SVHC substances	No
Approvals / Standards	
Certifications	DNV, BV
UL	ECBT2
cUL	ECBT8
General ordering information	
EAN13 code	8015747057677
Packaging Information	
Sub-packaging description	Plastic packaging
Sub-packaging quantity	5 Pcs
Sub-packaging EAN barcode	8015747106511

Part number

MMAP 16 CP32



Catalogue drawings

CMP CMAP - MMP MMAP

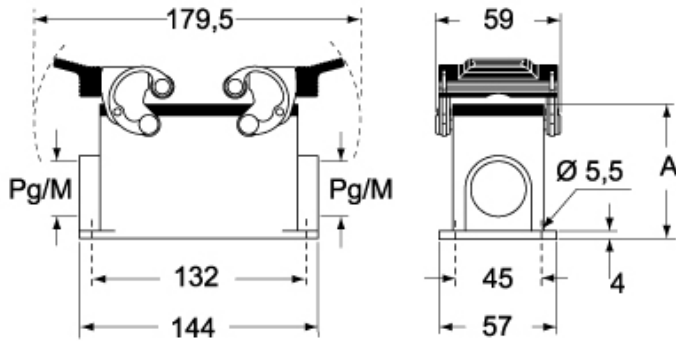

CMP CS/CP CMAP CS/CP - MMP CS/CP MMAP CS/CP

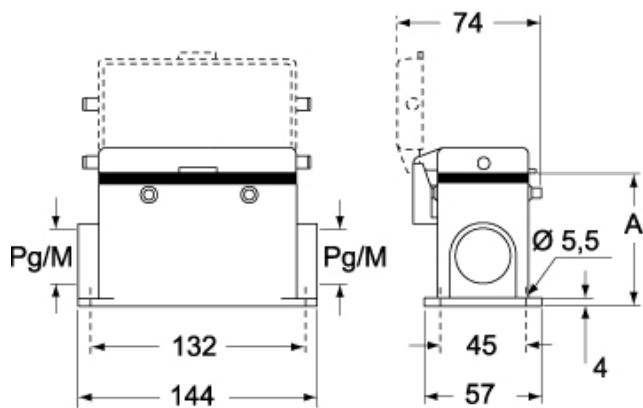

	A
CMP / MMP	63
CMAP / MMAP	80
CMP CS / MMP CS	63
CMAP CS / MMAP CS	80
CMP CP / MMP CP	63
CMAP CP / MMAP CP	80