

Part number

# MHO 16 X32



Hood, C-TYPE series, with 2 levers, M32 side cable entry, size "77.27", without gasket

#### Product description

<b>Product type</b>	Hood
<b>Series</b>	C-TYPE
<b>Closing type</b>	With 2 levers
<b>Size</b>	Size 77.27
<b>Cable entry</b>	Side cable entry M32
<b>Specification</b>	Without gasket

#### Technical data

<b>IP degree of protection</b>	IP65 / IP66 / IP69
--------------------------------	--------------------

#### Further technical details

<b>Weight</b>	250,00 g
<b>Operating temperature range (min, max)</b>	-40°C...+125°C

#### Material properties

<b>Other materials</b>	Lever: Stainless steel, polyamide (PA)
<b>Colour</b>	RAL 7040 grey
<b>RoHs conformity</b>	Compliant
<b>China RoHs - EFUP</b>	E
<b>REACH SVHC substances</b>	No

#### Approvals / Standards

<b>Certifications</b>	DNV, BV
<b>UL</b>	ECBT2
<b>cUL</b>	ECBT8

#### General ordering information

<b>EAN13 code</b>	8015747053365
<b>eCl@ss 8.1</b>	27440202
<b>ETIM 7.0</b>	EC000437

#### Packaging Information

<b>Packaging length</b>	300,00 mm
<b>Packaging height</b>	160,00 mm
<b>Packaging width</b>	180,00 mm
<b>Packaging weight</b>	2,97 kg
<b>Packaging volume</b>	8,64 dm <sup>3</sup>
<b>Packaging description</b>	Carton box
<b>Packaging quantity</b>	10 Pcs
<b>Packaging EAN code</b>	8015747053372
<b>Sub-packaging weight</b>	1,49 kg
<b>Sub-packaging description</b>	Plastic packaging
<b>Sub-packaging quantity</b>	5 Pcs
<b>Sub-packaging EAN barcode</b>	8015747053389

Part number

# MHO 16 X32



Catalogue drawings

**CHO X (CAO X) - MHO X (MAO X)**

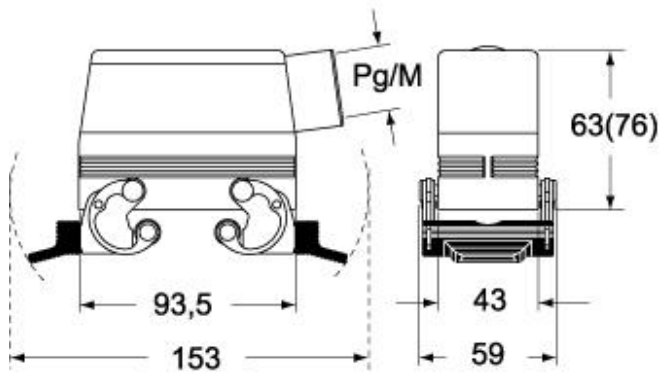

**CHV X (CAV X) - MHV X (MAV X)**

