

Part number

MGO 16.32



Hood, IP68 series, with 2 screws, M32 side cable entry, size "77.27"

Product description		Material properties	
Product type	Hood	Main material	Aluminium die-cast
Series	IP68	Other materials	Screws: Stainless steel
Closing type	With 2 screws	Colour	RAL 9005 black
Size	Size 77.27	RoHs conformity	Compliant
Cable entry	Side cable entry M32	China RoHs - EFUP	E
Technical data		REACH SVHC substances	No
IP degree of protection	IP66 / IP68 / IP69	Approvals / Standards	
Further technical details		Certifications	DNV, BV
Weight	525,50 g	UL	ECBT2
Operating temperature range (min, max)	-40°C...+125°C	cUL	ECBT8
		General ordering information	
		EAN13 code	8015747142229
		eCl@ss 8.1	27440202
		ETIM 7.0	EC000437
		Packaging Information	
		Packaging length	175,00 mm
		Packaging height	135,00 mm
		Packaging width	130,00 mm
		Packaging weight	1,13 kg
		Packaging volume	3,07 dm ³
		Packaging description	Carton box
		Packaging quantity	2 Pcs
		Packaging EAN code	8015747142526
		Sub-packaging weight	0,57 kg
		Sub-packaging description	Plastic packaging
		Sub-packaging quantity	1 Pcs
		Sub-packaging EAN barcode	8015747142533

Part number

MGO 16.32



Catalogue drawings

CGO/MGO CGV/MGV

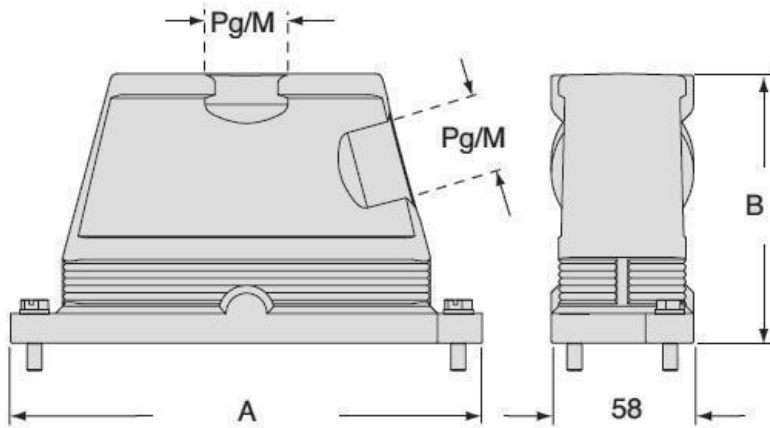

		A	B
CGO/MGO	CGV/MGV 06	133	101
CGO/MGO	CGV/MGV 10	146	101
CGO/MGO	CGV/MGV 16	166	111
CGO/MGO	CGV/MGV 24	193	111