

Part number

MAV 10 G32



Hood, C-TYPE series, with 2 levers, M32 top cable entry, size "57.27", high construction

Product description		Material properties	
Product type	Hood	Other materials	Lever: Stainless steel, polyamide (PA) Gasket: NBR
Series	C-TYPE	Colour	RAL 7040 grey
Closing type	With 2 levers	RoHs conformity	Compliant with exemption 6(c): copper alloy containing up to 4% lead by weight
Size	Size 57.27	China RoHs - EFUP	50
Cable entry	Top cable entry with adapter M32	REACH SVHC substances	Yes Lead
Specification	High construction	SCIP number	15deaf78-e939-4401-a0b0-e2228ca32a03
Technical data		Approvals / Standards	
IP degree of protection	IP65 / IP66 / IP69	Certifications	DNV, BV
Further technical details		UL	ECBT2
Weight	296,00 g	cUL	ECBT8
Operating temperature range (min, max)	-40°C...+125°C	General ordering information	
		EAN13 code	8015747052177
		eCl@ss 8.1	27440202
		ETIM 7.0	EC000437
		Packaging Information	
		Sub-packaging weight	1,48 kg
		Sub-packaging description	Plastic packaging
		Sub-packaging quantity	5 Pcs
		Sub-packaging EAN barcode	8015747052184

Part number

MAV 10 G32



Catalogue drawings

**CHO [CAO] CHV (CAV) - MHO [MAO]
MHV (MAV)**

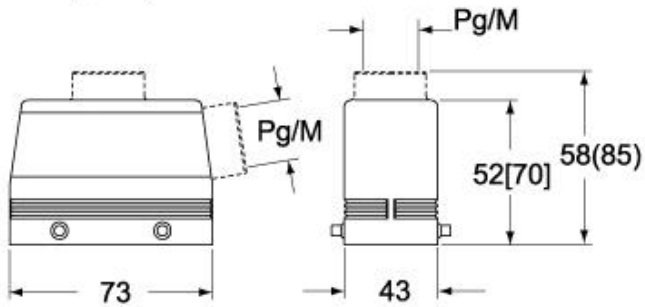

CAF - MAF/MFF

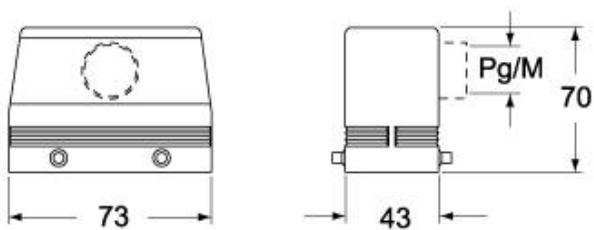

CHV G (CAV G) - MHV G (MAV G) - [MFV G]

