

Part number

# JCVP 10 LP



Surface mounting housing, JEI®-V series, with 1 lever, Pg16 cable entry, size "57.27", with plastic cover

#### Product description

<b>Product type</b>	Surface mounting housing
<b>Series</b>	JEI®-V
<b>Closing type</b>	With 1 lever
<b>Size</b>	Size 57.27
<b>Cable entry</b>	With cable entry Pg16
<b>Specification</b>	With plastic cover

#### Technical data

<b>IP degree of protection</b>	IP65
<b>Further technical details</b>	
<b>Weight</b>	276,00 g
<b>Operating temperature range (min, max)</b>	-40°C...+125°C

#### Material properties

<b>Other materials</b>	Lever: Galvanized steel Gasket: NBR
<b>Colour</b>	RAL 7040 grey

#### Approvals / Standards

<b>Certifications</b>	DNV, BV
<b>UL</b>	ECBT2
<b>cUL</b>	ECBT8

#### General ordering information

<b>EAN13 code</b>	8015747137744
-------------------	---------------

#### Packaging Information

<b>Packaging length</b>	370,00 mm
<b>Packaging height</b>	140,00 mm
<b>Packaging width</b>	210,00 mm
<b>Packaging weight</b>	3,01 kg
<b>Packaging volume</b>	10,88 dm <sup>3</sup>
<b>Packaging description</b>	Carton box
<b>Packaging quantity</b>	10 Pcs
<b>Packaging EAN code</b>	8015747144124
<b>Sub-packaging weight</b>	1,51 kg
<b>Sub-packaging description</b>	Plastic packaging
<b>Sub-packaging quantity</b>	5 Pcs
<b>Sub-packaging EAN barcode</b>	8015747140416

Part number

# JCVP 10 LP



Catalogue drawings

## JCVP LP

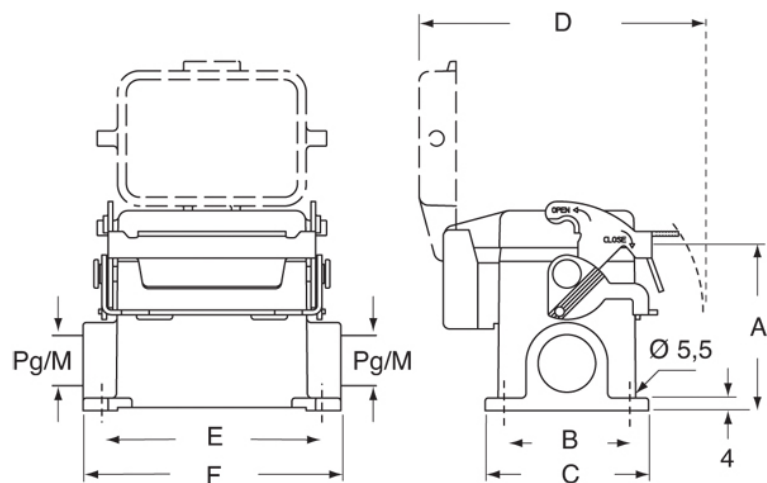

	A	B	C	D	E	F
JCVP 06 LP	53	40	52	91	70	82
JCVP 10 LP	57	40	52	94	82	93,5
JCVP 16 LP	63	45	57	94	105	117
JCVP 24 LP	63	45	57	94	132	144