

Part number

# CX 02 PDM



Docking frame, float-mount, 2 modules, size 44.27

Product description	
<b>Product type</b>	Docking frame
<b>Size</b>	Size 44.27
<b>Specification</b>	For 2 modular inserts and enclosures size 44.27
Technical data	
<b>IP degree of protection</b>	IP20
Further technical details	
<b>Mating cycles</b>	≥ 500   ≥ 10000 (MIXO units with HNM contacts)
<b>Weight</b>	1,00 g
<b>Operating temperature range (min, max)</b>	-40°C ... +125°C
<b>UL 94 flammability rating</b>	V-0

Material properties	
<b>Main material</b>	Polycarbonate (PC)
<b>Colour</b>	RAL 7032 grey
<b>RoHs conformity</b>	Compliant
<b>China RoHs - EFUP</b>	E
<b>REACH SVHC substances</b>	No
General ordering information	
<b>EAN13 code</b>	8015747303163
<b>eCl@ss 8.1</b>	27440210
<b>ETIM 7.0</b>	EC002310
Packaging Information	
<b>Packaging description</b>	Carton box
<b>Packaging quantity</b>	10 Pcs
<b>Packaging EAN code</b>	8015747303217
<b>Sub-packaging description</b>	Plastic bag
<b>Sub-packaging quantity</b>	1 Pcs
<b>Sub-packaging EAN barcode</b>	8015747303224

Part number

# CX 02 PDM



Catalogue drawings

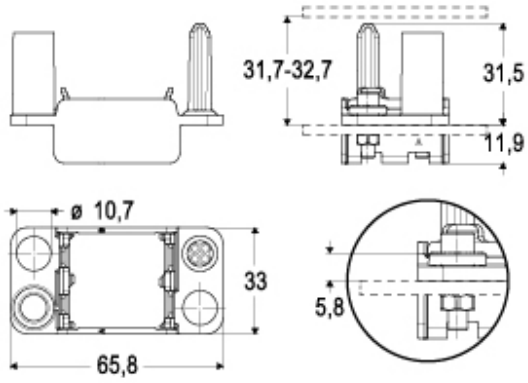

Catalogue drawings

