

Part number

CMP 06 LS



Surface mounting housing, 830V series, with 1 lever, Pg21 cable entry, size "77.27", with metal cover

Product description

Product type	Surface mounting housing
Series	830V
Closing type	With 1 lever
Size	Size 77.27
Cable entry	With cable entry Pg21
Specification	With metal cover

Technical data

IP degree of protection IP65

Further technical details

Weight	363,00 g
Operating temperature range (min, max)	-40°C...+125°C

Material properties

Colour	RAL 7040 grey
RoHs conformity	Compliant
China RoHs - EFUP	E
REACH SVHC substances	No

Approvals / Standards

Certifications	DNV, BV
UL	ECBT2
cUL	ECBT8

General ordering information

EAN13 code 8015747031493

Packaging Information

Packaging length	180,00 mm
Packaging height	210,00 mm
Packaging width	330,00 mm
Packaging weight	3,89 kg
Packaging volume	12,47 dm ³
Packaging description	Carton box
Packaging quantity	10 Pcs
Packaging EAN code	8015747231466
Sub-packaging weight	1,95 kg
Sub-packaging description	Plastic packaging
Sub-packaging quantity	5 Pcs
Sub-packaging EAN barcode	8015747231473

Part number

CMP 06 LS



Catalogue drawings

CMP L CMAP L - MMP L MMAP L



CMP LS CMAP LS - MMP LS MMAP LS

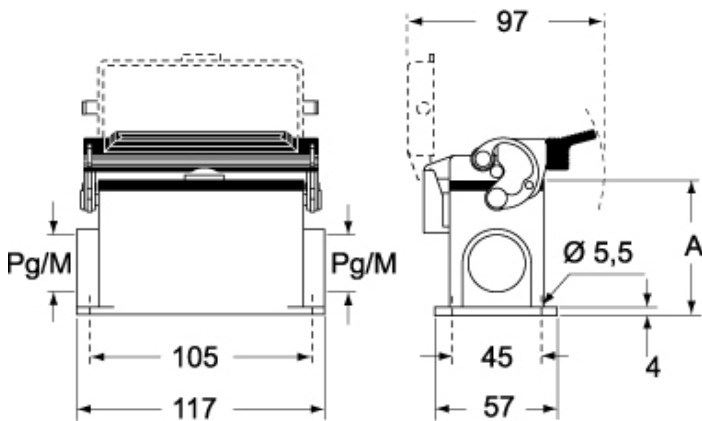

	A
CMP L / MMP L	63
CMAP L / MMAP L	77
CMP LS / MMP LS	63
CMAP LS / MMAP LS	77