

Part number

CMAV 16 L29



Hood, 830V series, with 2 pegs, Pg29 top cable entry, size "104.27", high construction

Product description

Product type	Hood
Series	830V
Closing type	With 2 pegs
Size	Size 104.27
Cable entry	Top cable entry Pg29
Specification	High construction

Technical data

IP degree of protection IP65 / IP66 / IP69

Further technical details

Weight	245,00 g
Operating temperature range (min, max)	-40°C...+125°C

Material properties

Colour	RAL 7040 grey
RoHS conformity	Compliant
China RoHS - EFUP	E
REACH SVHC substances	No

Approvals / Standards

Certifications	DNV, BV
UL	ECBT2
cUL	ECBT8

General ordering information

EAN13 code 8015747029971

Packaging Information

Sub-packaging weight	1,23 kg
Sub-packaging description	Plastic packaging
Sub-packaging quantity	5 Pcs
Sub-packaging EAN barcode	8015747029988

Part number

CMAV 16 L29



Catalogue drawings

**CMO L (CMAO L) - MMO L [MMAO L]
CMV L [CMAV L] - MMV L (MMAV L)**

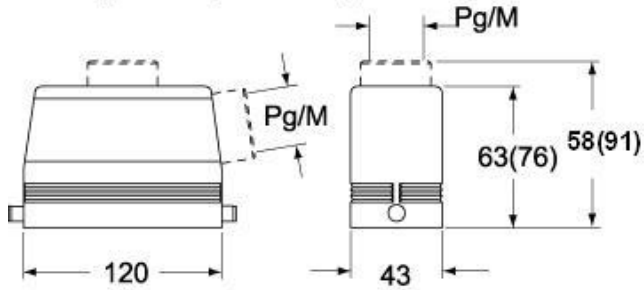

Catalogue drawings

**CMO L (CMAO L) - MMO L [MMAO L]
CMV L [CMAV L] - MMV L (MMAV L)**

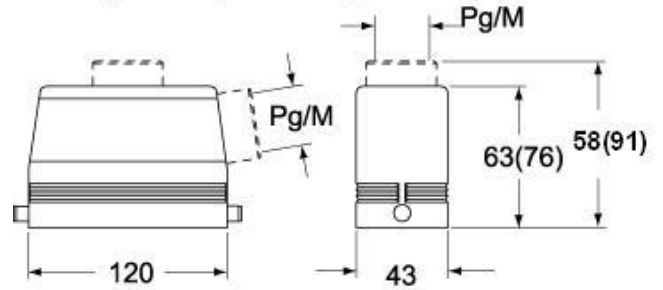

**CMV LG (CMAV LG) - MMV LG (MMAV LG)
[MMFV LG]**

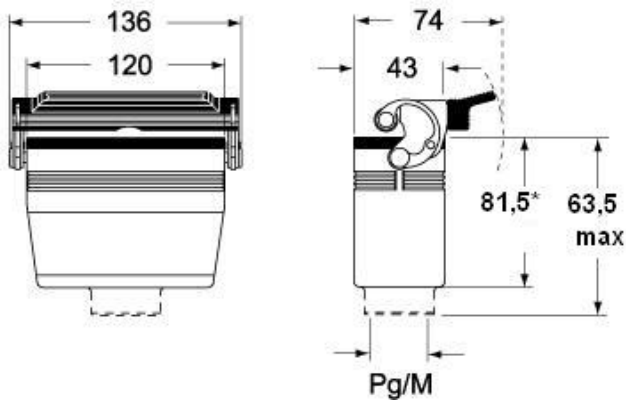

**CMV LG (CMAV LG) - MMV LG (MMAV LG)
[MMFV LG]**

