

Part number

CHP 50.29



Surface mounting housing, C-TYPE series, with 2 levers, Pg29 cable entry, size "66.40"



Product description		Material properties	
Product type	Surface mounting housing	Other materials	Lever: Stainless steel, polyamide (PA) Gasket: NBR
Series	C-TYPE	Colour	RAL 7040 grey
Closing type	With 2 levers	RoHs conformity	Compliant
Size	Size "66.40"	China RoHs - EFUP	E
Cable entry	With cable entry Pg29	REACH SVHC substances	No
Technical data		Approvals / Standards	
IP degree of protection	IP65 / IP66 / IP69	Certifications	DNV, BV
Further technical details		UL	ECBT2
Weight	456,00 g	cUL	ECBT8
Operating temperature range (min, max)	-40°C...+125°C	General ordering information	
		EAN13 code	8015747023306
		Packaging Information	
		Packaging length	350,00 mm
		Packaging height	105,00 mm
		Packaging width	145,00 mm
		Packaging weight	2,44 kg
		Packaging volume	5,33 dm ³
		Packaging description	Carton box
		Packaging quantity	5 Pcs
		Packaging EAN code	8015747023313

Part number

CHP 50.29



Catalogue drawings

CHP - MHP



CHP CS - MHP CS

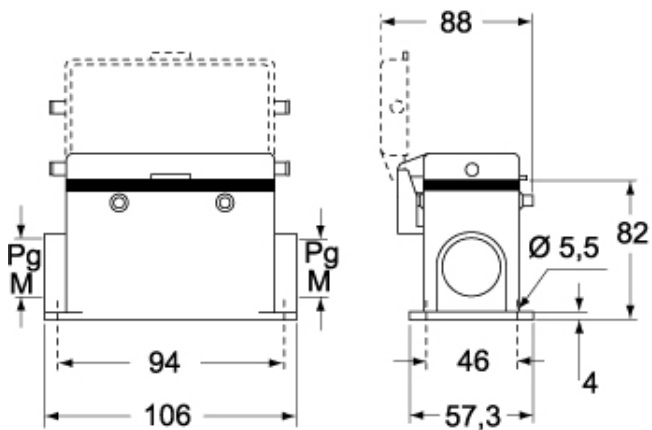

Catalogue drawings

