

Part number

CDF 40

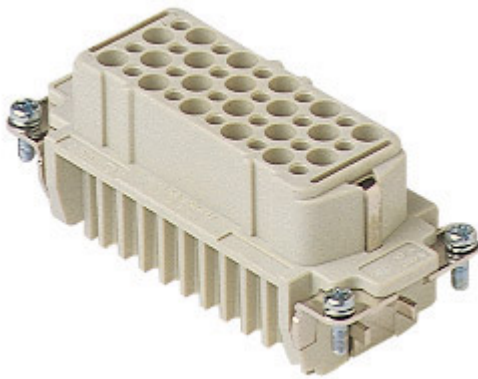

Female insert, CD series, crimp connection, 40 poles + PE, 10 A 250 V 4 kV 3, size "77.27"

Product description

Product type	Insert
Series	CD
Connection type	Crimp connection
Gender	Female
N. of poles	40 poles +
Size	Size 77.27

Technical data

Current	10 A
Voltage	250 V
Rated impulse withstand voltage	4 kV
Pollution degree	3
Rated voltage according to UL/CSA	600 V
IP degree of protection	IP20 without enclosure, IP65/IP66/IP68/IP69 with enclosure

Further technical details

Characteristics according to EN 61984	10A 250V 4kV 3; 10A 230/400V 4kV 2
Mating cycles	≥ 500
Insulation resistance	≥ 10 GΩ
Contact resistance	≤ 3 mΩ
Weight	62,00 g
Operating temperature range (min, max)	-40 °C ... +125 °C
Conductors stripping length	6 - 8 mm
UL 94 flammability rating	V-0
Tightening torque for PE connection	M4: 1,2 Nm, 10,6 lb.in (Ph2 or 1,0x5,5mm)
Tightening torque for fixing screws	M3: 0.5 Nm; 4.4 lb.in (Ph1 or 0.8x4 mm)

Material properties

Main material	Polycarbonate (PC)
Colour	RAL 7032 grey
RoHs conformity	Compliant
China RoHs - EFUP	E
REACH SVHC substances	No

Approvals / Standards

Reference standard	EN 61984:2009-06
Certifications	CSAc, CQC, DNV, BV, EAC
UL	ECBT2
cUL	ECBT8

General ordering information

EAN13 code	8015747014427
eCl@ss 8.1	27440205
ETIM 7.0	EC000438

Packaging Information

Packaging length	230,00 mm
Packaging height	110,00 mm
Packaging width	180,00 mm
Packaging weight	1,96 kg
Packaging volume	4,55 dm ³
Packaging description	Carton box
Packaging quantity	30 Pcs
Packaging EAN code	8015747014434
Sub-packaging length	87,00 mm
Sub-packaging height	36,00 mm
Sub-packaging width	180,00 mm
Sub-packaging weight	0,33 kg
Sub-packaging volume	0,56 dm ³
Sub-packaging description	Carton tray
Sub-packaging quantity	5 Pcs
Sub-packaging EAN barcode	8015747014441

Part number

CDF 40



Catalogue drawings

CDM 40

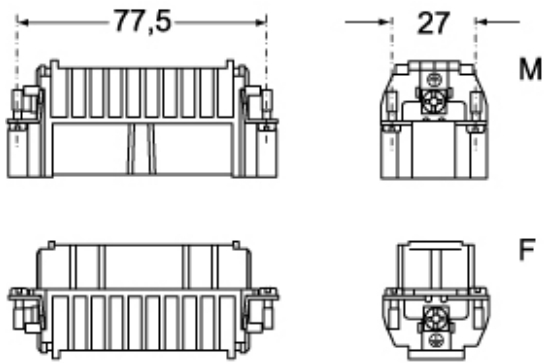

CDF 40

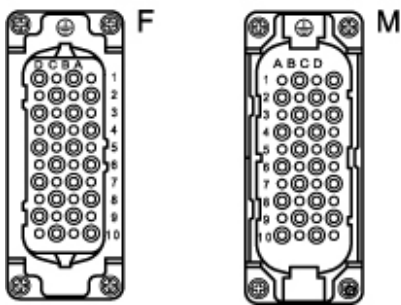

Catalogue drawings

diagram CD 40 and 80 poles

